

PLEASE READ

This manual is provided as a free service by Projector.com.

We are in no way responsible for the contents of the manual. We do not guarantee its accuracy and we do not make any claim of copyright. The copyright remains the property of their respective owners.

ABOUT PROJECTOR.COM

Projector.com (<http://www.projector.com>) is your review and buying guide resource for DLP and LCD video projectors.

Visit the site to read the latest projector news and reviews, read and comment on projector specifications, download user manuals and much more.

BARCO

BARCO PROJECTION SYSTEMS

BARCO DATA
808

R9002030

R9002039

OWNER'S MANUAL

Date:
250496

Rev. :
01

Art. No.
R5975426

Due to constant research, the information in this manual is subject to change without notice.

Produced by BARCO NV, April 1996
All rights reserved.

Trademarks are the rights of their respective owners.

Printed in Belgium.

CONTENTS

WARNINGS	1-1
SAFETY INSTRUCTIONS	1-1
On safety	1-4
On installation	1-5
On servicing	1-6
On cleaning	1-6
On repacking	1-7
On illumination	1-7
LOCATION AND FUNCTION OF CONTROLS	2-1
Rear panel terminology	2-2
Front panel terminology	2-3
RCU control panel terminology	2-4
AC POWER (MAINS) CONNECTION	3-1
Power (mains) cord connection	3-2
Power check	3-2
Switching on	3-3
SOURCE CONNECTIONS	4-1
Signal input connection to the projector :	4-2
Connecting a Composite Video source to port 1.	4-3
Connecting an S-Video source to port 2	4-4
Connecting a RGB Analog source to port 3.	4-5
Connecting a RGB analog source to port 4/5.	4-6
Connecting a RGB Analog source with Tri-level sync to port 4/5	4-7
Peripheral equipment	4-8
Connecting a RCVDS800 or RCVDS05 switcher to the BARCODATA 808 ...	4-8
Connecting a VS 05 switcher to the BARCODATA 808.	4-8
Connecting an IR Remote Receiver to the BARCODATA 808.	4-8
CONTROLLING THE PROJECTOR WITH THE REMOTE CONTROL UNIT (RCU)	5-1
Battery installation in the RCU.	5-2
How to use the RCU	5-3
Projector Address	5-5
How to display a projector address?	5-6
How to program an address into the RCU?	5-6
Input selection	5-6
Analog Picture Controls	5-8
Controlling chained projectors.	5-10
START UP OF THE ADJUSTMENT MODE	6-1
Entering the adjustment mode	6-2
Adjustment Mode	6-3
GUIDED ADJUSTMENT MODE	7-1
Start-Up of the Guided Adjustment Mode	7-2
Overview flowchart 'Guided Adjustment' procedure.	7-3
Selecting Setup Pattern	7-5

Internal Cross Hatch Pattern 7-6
 Picture tuning toggle switches 7-7
 Sync Fast/Slow toggle 7-7
 Enhanced Blue ON/OFF 7-8
 Raster Centering on Green CRT Faceplate 7-8
 Shifting Red and Blue on Green 7-10
 Focusing 7-10
 Left-Right (East-West) Adjustments 7-11
 Vertical Centerline Bow Adjustment 7-12
 Vertical Centerline Skew Adjustment 7-12
 Side Bow Adjustment 7-13
 Side Keystone Adjustment 7-13
 Seagull Correction 7-14
 Left Right Corrections 7-14
 Left Keystone Correction 7-15
 Left Bow Correction 7-15
 Horizontal Size Adjustment 7-16
 Top-Bottom (North-South) Adjustments 7-17
 Horizontal Centerline Bow Adjustment 7-17
 Horizontal Centerline Skew Adjustment 7-17
 Top Bow Adjustment 7-17
 Top Keystone Adjustment 7-19
 Bottom Bow Adjustment 7-19
 Bottom Keystone Adjustment 7-20
 Seagull Correction 7-20
 Size-Linearity Adjustment 7-21
 Vertical Linearity Adjustment 7-21
 Vertical Size Adjustment 7-22
 Horizontal Phase Adjustment 7-23
 Convergence Adjustments 7-24
 Blanking Adjustments 7-26
 Top blanking adjustment 7-27
 Bottom blanking adjustment 7-27
 Left blanking adjustment 7-28
 Right blanking adjustment 7-28
 Color Balance 7-29

RANDOM ACCESS ADJUSTMENT MODE 8-1
 Starting-Up the Random Access Adjustment mode 8-2
 Overview flowchart 'Random Access Adjustment' mode 8-3
 Selecting Setup Pattern 8-5
 Internal Cross Hatch Pattern 8-6
 Random access adjustment mode selection menu 8-7
 Picture Tuning 8-7
 Color Balance 8-8
 Sync Fast/Slow Adjustment 8-9
 Enhanced Blue On/Off Adjustment 8-9
 Color Select 8-10
 Focusing 8-11
 Focusing color select. 8-11

CONTENTS

Midpoint focusing	8-12
Top image focusing	8-13
Bottom image focusing	8-13
Left image focusing	8-13
Right image focusing	8-14
Geometry Adjustments	8-14
Horizontal Phase Adjustment	8-15
Raster Shift Adjustment	8-17
Left-Right (east-west) Adjustments	8-19
Vertical Centerline Bow Adjustment	8-20
Vertical Centerline Skew Adjustment	8-21
Side Bow Adjustment	8-22
Side Keystone Adjustment	8-23
Seagull Correction	8-24
Left Side Corrections	8-25
Left keystone	8-26
Left bow	8-27
Top-Bottom (north-south) Adjustments	8-28
Horizontal Centerline Bow Adjustment	8-29
Horizontal Centerline Skew Adjustment	8-30
Top Bow Adjustment	8-31
Top Keystone Adjustment	8-32
Bottom Bow Adjustment	8-33
Bottom Keystone Adjustment	8-34
Seagull Corrections	8-35
Horizontal Size Adjustment	8-36
Vertical Linearity Adjustment	8-37
Vertical Size Adjustment	8-38
Blanking Adjustments	8-39
Top Blanking Adjustment	8-40
Bottom Blanking Adjustment	8-41
Left Blanking Adjustment	8-42
Right Blanking Adjustment	8-43
Convergence Adjustment	8-44
SERVICE MODE	9-1
Starting Up the Service mode	9-2
Overview flowchart 'Service' mode	9-3
Identification	9-6
Change password	9-7
Run time	9-8
Set to Midposition	9-9
Convergence mid	9-10
CRT Run In Cycle	9-11
Copy a block	9-12
Deletion of blocks	9-13
Deleting block by block	9-13
Deletion of all blocks	9-14

G2 adjust	9-15
Change language	9-16
Projector warm up	9-17
MESSAGES, WARNINGS AND FAILURES	10-1
OPTIONS	11-1
IR Receiver 800	11-2
Hardwired RCU	11-2
Projector Control software	11-3
RCVDS 800 and RCVDS 05 Switchers	11-3
VS05 Switcher	11-3
IRIS 800 Auto-Convergence Unit	11-3
Adapter and communication cables	11-4
Ceiling Mount kit CM100	11-4
Orbiting Kit	11-4
Soft Edge Matching Kit	11-5
Contrast Modulation Kit	11-5
Appendix A : Orbiting	A-1
Appendix B : Soft edge matching	B-1
Appendix C : Contrast modulation	C-1
Appendix D : Battery replacement in the RCU	D-1
Appendix E : Adjustment Blocks	E-1
Appendix F : Source numbers 90 - 99	F-1

WARNINGS

SAFETY INSTRUCTIONS

On Safety

On Installation

On Servicing

On Cleaning

On Repacking

On Illumination

Notice on Safety

Projectors are built in accordance with the requirements of the international safety standards IEC 950 and UL 1950, which are the safety standards of information technology equipment including electrical business equipment.

These safety standards impose important requirements on the use of safety critical components, materials and isolation, in order to protect the user or operator against risk of electric shock and energy hazard, and having access to live parts. Safety standards also impose limits to the internal and external temperature rises, radiation levels, mechanical stability and strength, enclosure construction and protection against the risk of fire.

Simulated single fault condition testing ensures the safety of the equipment to the user even when the equipment's normal operation fails.

INSTALLATION INSTRUCTIONS

Before operating your projector please read this manual thoroughly, and retain it for future reference.

Installation and preliminary adjustments should be performed by qualified BARCO personnel or by authorized BARCO service dealers.

OWNER'S RECORD

The part number and serial number are located at the left side of the projector. Record these numbers in the spaces provided below. Refer to them whenever you call upon your BARCO dealer regarding this product.

PART NUMBER :

SER. NUMBER :

DEALER :

SAFETY INSTRUCTIONS

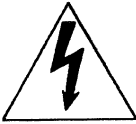
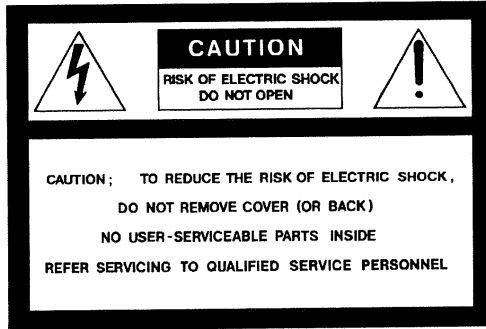

The lightning flash with an arrowhead within a triangle is intended to tell the user that parts inside this product may cause a risk of electrical shock to persons.



The exclamation point within a triangle is intended to tell the user that important operating and/or servicing instructions are included in the technical documentation for this equipment.

WARNING
TO PREVENT FIRE OR ELECTRICAL SHOCK HAZARD, DO NOT EXPOSE THIS PROJECTOR TO RAIN OR MOISTURE

FEDERAL COMMUNICATION COMMISSION (FCC STATEMENT)

This equipment has been tested and found to comply with the limits of a class B digital device, pursuant to Part 15 of the FCC Rules. These limits are designed to provide reasonable protection against harmful interference in a residential installation. This equipment generates, uses and can radiate radio frequency energy and, if not installed and used in accordance with the instructions, may cause harmful interference to radio communications. However, there is no guarantee that interference will not occur in a particular installation. If this equipment does cause harmful interference to radio or television reception, which can be determined by turning the equipment off and on, the user is encouraged to try to correct the interference by one or more of the following measures:

- Reorient or relocate the receiving antenna.
- Increase the separation between the equipment and receiver.
- Connect the equipment into an outlet on a circuit different from that to which the receiver is connected
- Consult the dealer or an experienced radio/TV technician for help.

- * All the safety and operating instructions should be read before using this unit.
- * The safety and operating instructions manual should be retained for future reference.
- * All warnings on the projector and in the documentation manuals should be adhered to.
- * All instructions for operating and use of this equipment must be followed precisely.

On Safety

1. This product should be operated from an AC power source

Operating AC power voltage of the projector:

BARCODATA 808

Art.No. R9002030 (230V AC)

Art. No. R9002039 (120 V AC)

Consult your dealer to switch over from 230 Vac to 120 Vac or from 120 V ac to 230 V ac.

If you are not sure of the type of AC power available, consult your dealer or local power company.

2. This product is equipped with a 3-wire grounding plug, a plug having a third (grounding) pin. This plug will only fit into a grounding-type power outlet. This is a very important safety feature. If you are unable to insert the plug into the outlet, contact your electrician to replace your obsolete outlet. **DO NOT DEFEAT THE PURPOSE OF THE GROUNDING-TYPE PLUG.**

WARNING FOR THE CUSTOMERS: THIS APPARATUS MUST BE GROUNDED (EARTHED) via the supplied 3 conductor AC power cable.
(If the supplied power cable is not the correct one, consult your dealer.)

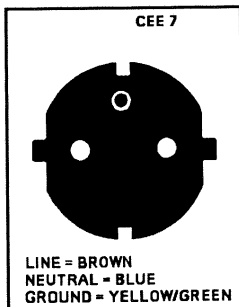

A. Mains Lead (Power cord) with CEE 7 plug:

The wires of the means lead are colored in accordance with the following code.

Green and yellow:	earth (safety earth)
Blue:	neutral
Brown:	line (live)

SAFETY INSTRUCTIONS

B. Power cord with ANSI 73.11 plug:

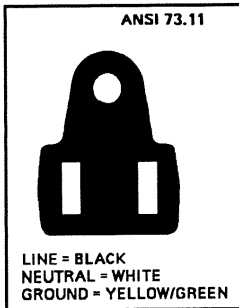

The wires of the power cord are colored in accordance with the following code.

Green/yellow: ground
White: neutral
Black: line (live)

3. Do not allow anything to rest on the power cord. Do not locate this product where persons will walk on the cord.

To disconnect the cord, pull it out by the plug. Never pull the cord itself.

4. If an extension cord is used with this product, make sure that the total of the ampere ratings on the products plugged into the extension cord does not exceed the extension cord ampere rating. Also make sure that the total of all products plugged into the wall outlet does not exceed 15 amperes.

5. Never push objects of any kind into this product through cabinet slots as they may touch dangerous voltage points or short out parts that could result in a risk of fire or electrical shock.

Never spill liquid of any kind on the product. Should any liquid or solid object fall into the cabinet, unplug the set and have it checked by qualified service personnel before resuming operations.

6. Lightning - For added protection for this video product during a lightning storm, or when it is left unattended and unused for long periods of time, unplug it from the wall outlet. This will prevent damage to the projector due to lightning and AC power-line surges.

On Installation

1. Do not place this projector on an unstable cart, stand, or table. The projector may fall, causing serious damage to it.

2. Do not use this projector near water.

3. Slots and openings in the cabinet and the back or bottom are provided for ventilation; to ensure reliable operation of the projector and to protect it from overheating, these openings must not be blocked or covered. The openings should never be blocked by placing the product on a bed, sofa, rug, or other similar surface.

This product should never be placed near or over a radiator or heat register. This projector should not be placed in a built-in installation or enclosure unless proper ventilation is provided.

On Servicing

Do not attempt to service this projector yourself, as opening or removing covers may expose you to dangerous voltage potentials and risk of electric shock!

Refer all servicing to qualified service personnel !

Unplug this product from the wall outlet and refer servicing to qualified service personnel under the following conditions:

- a. When the power cord or plug is damaged or frayed.
- b. If liquid has been spilled into the projector.
- c. If the product has been exposed to rain or water.
- d. If the product does not operate normally when the operating instructions are followed. Note : Adjust only those controls that are covered by the operating instructions since improper adjustment of the other controls may result in damage and will often require extensive work by a qualified technician to restore the product to normal operation.
- e. If the product has been dropped or the cabinet has been damaged.
- f. If the product exhibits a distinct change in performance, indicating a need for service.

Replacement parts - When replacement parts are required, be sure the service technician has used original BARCO replacement parts or authorized replacement parts which have the same characteristics as the BARCO original part. Unauthorized substitutions may result in degraded performance and reliability, fire, electric shock or other hazards. Use of unauthorized spare parts may void the product's warranty.

Safety check - Upon completion of any service or repairs to this projector, ask the service technician to perform safety checks to determine that the projector is in proper operating condition.

On Cleaning

Unplug this product from the wall outlet before cleaning. Do not use liquid cleaners or aerosol cleaners. Use a damp cloth for cleaning.

- To keep the cabinet looking brand-new, periodically clean it with a soft cloth. Stubborn stains may be removed with a cloth lightly dampened with mild detergent solution. Never use strong solvents, such as paint thinner or benzine, or abrasive cleaners, since these will damage the cabinet.

SAFETY INSTRUCTIONS

- To ensure the highest optical performance and resolution, the projection lenses are specially treated with an anti-reflective coating, therefore, avoid touching the lens. To remove dust on the lens, use a soft dry cloth. Do not use a damp cloth, detergent solution, or other cleaning products.

On Repacking

Save the original shipping carton and packing material; they may come in handy if you ever have to ship your projector. For maximum protection, repack your set as it was originally packed at the factory.

On Illumination

In order to obtain the best quality for the projected image, it is essential that the ambient light which is allowed to fall on the screen be kept to an absolute minimum.

When installing the projector and screen, care must be taken to avoid exposure to ambient light directly on the screen. Avoid adverse illumination on the screen from direct sunlight or florescent lighting fixtures.

The use of controlled ambient lighting, such as incandescent spot light or a dimmer, is recommended for proper room illumination. Where possible, care should also be taken to ensure that the floors and walls of the room in which the projector is to be installed are non-reflecting, dark surfaces. Brighter surfaces will tend to reflect and diffuse the ambient light and hence reduce the contrast of the projected image on the screen.

LOCATION AND FUNCTION OF CONTROLS

Rear Panel Terminology

Front Panel Terminology

RCU Terminology

REAR PANEL TERMINOLOGY

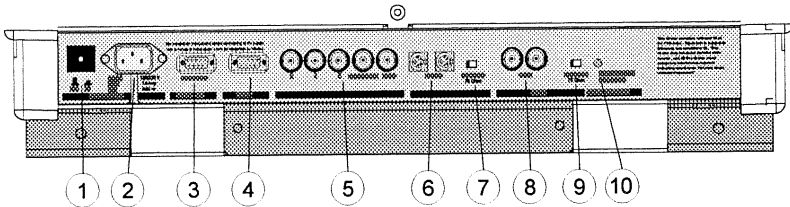

- 1 Power Switch** : press the switch to turn the projector ON.

Depending on the hardware set-up of the projector during installation, the projector switches to 'Standby' or to 'Operational' mode. If in standby, the standby LED lights up.
- 2 AC Power Input**
- 3 Communication Port (800 peripherals)**

 - * allows communication between the RCVDS switcher and the projector.
 - * allows connection of a remote IR receiver unit to the projector.
- 4 Port 3**

RGB Analog Input (9 pin female sub D connector): Allows a character generator, microcomputer, etc. having analog RGB outputs to be connected to the projector.
- 5 Port 4/5 : RGB-S Input (5x BNC connector):**

RGB-S input: allows a character generator, microcomputer, video camera, etc. having analog RGB output to be connected to the projector.

Line inputs: - signals RED-GREEN-BLUE
 - COMPOSITE sync. signal
- 6 S-VIDEO Input:** Separated Y/C (luma-chroma) signal inputs and outputs for higher quality playback of Super VHS signals (4-pin S-VIDEO connector loop-through).
- 7 75 ohm Termination Switch for S-Video signals**
- 8 VIDEO Input (Composite video, 2x loop-through BNC connector):** allows a video tape recorder, video camera, color receiver/monitor, etc. having video line output to be connected to the projector.

LOCATION AND FUNCTION OF CONTROLS

9

75 ohm Termination Switch for Video signals

10

Projector Pilot Lamp : indicates the status of the projector.

- unlit : mains (power) switch is not pressed.
- lit : mains (power) switch is pressed and the indicated color shows the projector mode:

Green color : operational mode of the projector.
Red color : standby mode of the projector.

Important : projector ("Operational" or "Standby") mode is defined during the installation of the projector. (Refer to a qualified technician for change).

FRONT PANEL TERMINOLOGY

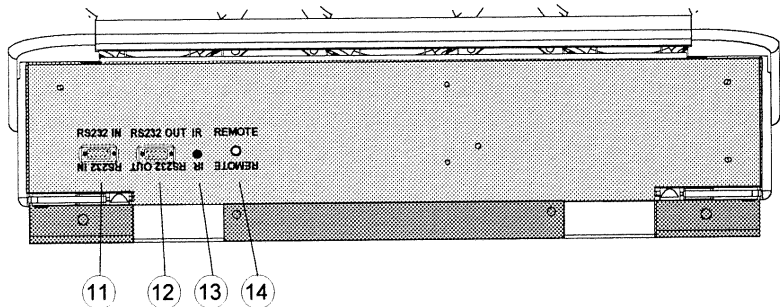

11

RS 232 Input Port

Connection between the BARCODATA 808 and an IBM PC (or compatible) or MAC (RS422) for remote computer control and data communication.

12

RS 232 Output Port

RS 232 Input Port allows a communication link for PC or MAC to the next projector in a series of projector.

13

IR Sensor

receiver for control signals transmitted from the RCU.

14

IR Remote

Connector for remote input for hard wired remote control

The Local Keypad

Getting Access

The local keypad is underneath the top cover door with the BARCO logo. To open this door, push as indicated on drawing and turn it to the front side of the projector.

This local keyboard has the same functions as the Remote Control Unit (RCU)

The terminology is explained in paragraph "RCU control panel terminology".

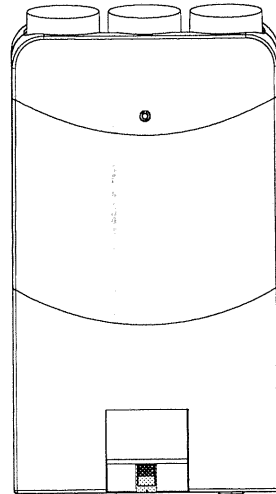
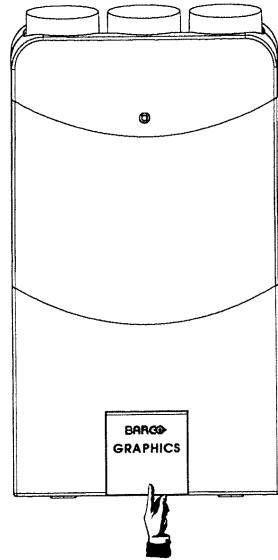

LOCATION AND FUNCTION OF CONTROLS

RCU control panel terminology

This remote control includes a battery powered infrared (IR) transmitter that allows the user to control the projector remotely.

This remote control is used for source selection, control, adaptation and set-up. It includes automatic storing of :

- picture controls (Brightness, Sharpness,....)
- picture geometry adjustments
- convergence adjustments

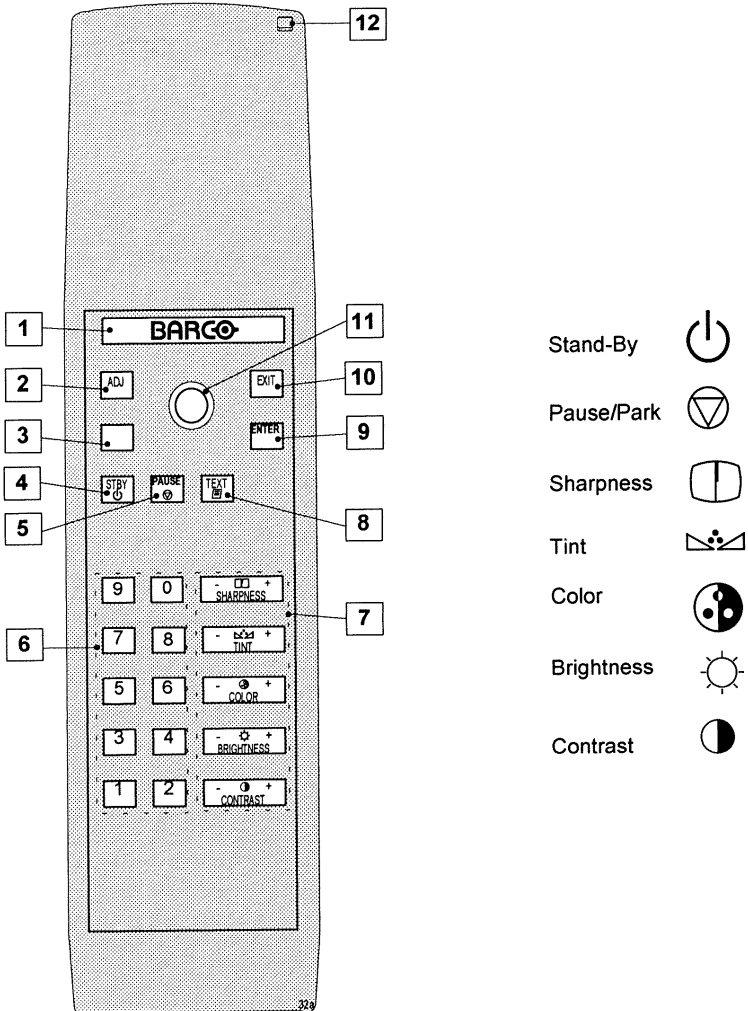

LOCATION AND FUNCTION OF CONTROLS

Other functions of the remote control are:

- switching between standby and operational modes
- switching to "pause" (blanked picture, full power for immediate restarting)
- direct access to all connected sources
- variable adjustment speed : when pushing continuously on the arrow keys or the picture keys, the adjustment will be executed in an accelerated fashion.

1 **Back Light Key** : when activated, all keys will be lit up and visible in the dark.

2 **ADJ.** : adjust key, to enter or exit the Adjustment mode.

3 **Address key** (sunk key), to enter the address of the projector (between 0 and 9). Press 'ADDR', followed by pressing one digit button between 0 and 9.

4 **STBY** : stand by button : - to initiate remote power up operation
- to stop projection without power off.

5 **Pause** :to blank the image, press PAUSE. The image disappears but full power is retained for immediate restarting.

6 **Digit Buttons** : direct input selection.

7 **Picture Controls** : use these buttons to obtain the desired level (see also 'Controlling') for each picture function.

8 **TEXT** : when adjusting one of the image controls during a presentation, the displayed bar scale can be removed by pressing 'TEXT' key first. To re-display the bar scale on the screen, press 'TEXT' key again. 'TEXT' key is only active in operational mode. When 'TEXT' is off, no warning messages or information will be displayed.

9 **ENTER** : to start up the Adjustment mode or to confirm an adjustment or selection in the adjustment mode. (move forward)

10 **EXIT** : to leave the Adjustment mode or to scroll upwards when in the adjustment mode.(move backward)

11 **JOY STICK key** : to make menu selections when in the Adjustment mode. Also allows to increment or decrement an adjustment in the adjustment mode.

Joy stick forward = up arrow in the menus

Joy stick backward = down arrow in the menus

Joy stick to the right = arrow to the right on the menus

Joy stick to the left = arrow to the left on the menus

LOCATION AND FUNCTION OF CONTROLS

12

RC Operating Indication : lights up when a button on the remote control is pressed. (This is a visual indicator to check the operation of the remote control)

POWER CONNECTION

AC POWER (MAINS) CONNECTION

POWER CONNECTION

AC Power (mains) Cord Connection

Use the supplied power cord to connect your projector to the wall outlet. Plug the female power connector into the male connector at the backside of the projector.

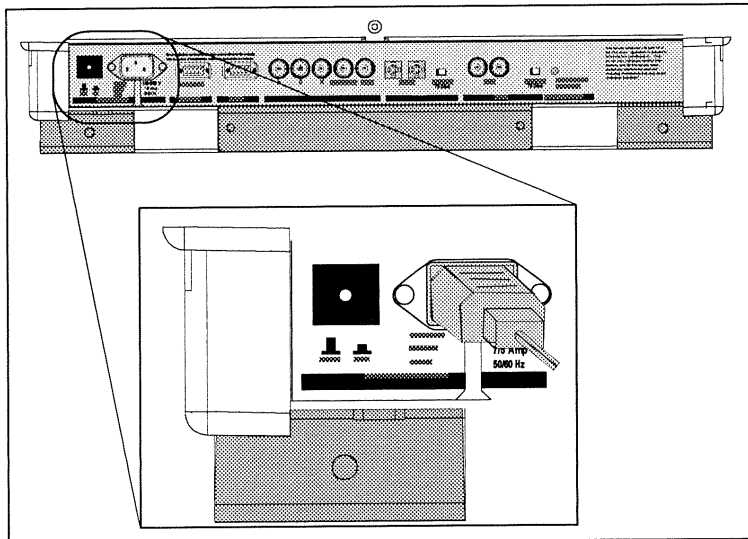
**Power Check**

Power voltage indication inside the cover door. Press on the indicated place to open the door.

Warning !

Check if the indicated power voltage corresponds to that of the wall outlet.

Art. No. R9002030 must be connected to a 230 VAC power source.

Art. No. R9002039 must be connected to a 120 VAC power source.

If the wall outlet voltage is different, call a qualified technician for power adaptation of the projector.

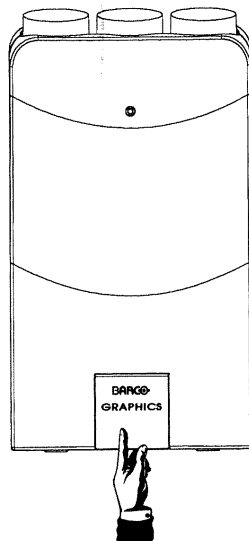

POWER CONNECTION

Switching On/Off

The projector is switched ON and OFF using the power (mains) switch ON/OFF.

Pressed : ON

Not pressed : OFF

The projector can start now in the 'operational mode' (image displayed) or in the 'stand by mode', depending on the position of the 'power up' dip switch on the controller unit. This DIP switch must be set during installation by a qualified technician. If you want to change this start up mode, call a qualified technician.

Stand by indication lamp :

no light up : projector switched off

green color : projector in Operational mode

red color : projector is in Standby mode.

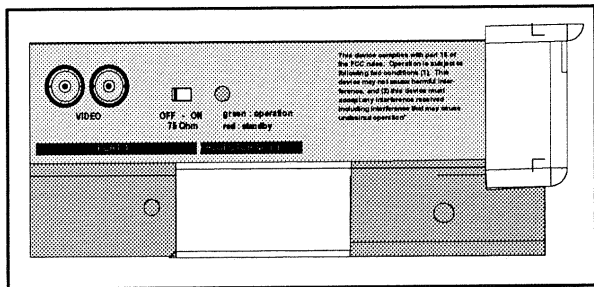

When starting up the projector, with the power switch or via the stand-by key, the projector can start up in two ways if the "CRT run in" cycle option is switched OFF.

- full white image (projector warm up) or
- immediately image display.

The way of starting up can be set in the service mode.

Start up with full white image.

The next menu will be displayed for 30 seconds.

- a. Start up with warm up period.

If no action is taken, a white image will be displayed for 20 minutes.

This white image will be shifted on the faceplate of the CRT to avoid a CRT burn in.

During this warm up period, it is

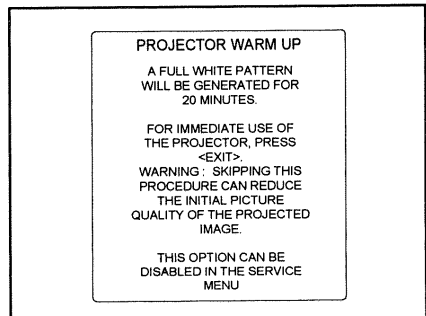

possible to interrupt this white image projection by pressing the EXIT key. The previous menu will be repeated for another 30 seconds but the remaining time will be indicated.

If EXIT is pressed, the remaining warm up period will be shipped.

During the warm up period, every 30 seconds a text box with the remaining time will be displayed on the screen for 2 seconds. This text box will be displayed every time on another place.

REMAINING
PROJECTOR
WARM UP
TIME
18.5MIN

If another key, different from EXIT, is pressed, a text box with following text will be displayed :

Please use <EXIT> to leave this procedure.

PLEASE USE
<EXIT> TO
LEAVE THIS
PROCEDURE

b. Start up without warm up period.

If the EXIT key is pressed, the warm up period will be skipped and the projector is immediately ready for use.

Warning : skipping this warm up procedure can reduce the initial picture quality of the projected image.

SOURCE CONNECTIONS

- connecting a Video source
- connecting a S-Video source
- connecting a RGsB or RGBS analog source
- connecting a RG3sB or RGB3S analog source

PERIPHERAL EQUIPMENT CONNECTION

- connecting a RCVDS 800 or RCVDS 05
- connecting a VS O5
- connecting an IR Remote Receiver

Signal Input Connection to the Projector :

- Composite Video
- S-Video
- RGSB or RGsB
- RGB3S or RG3sB (option)

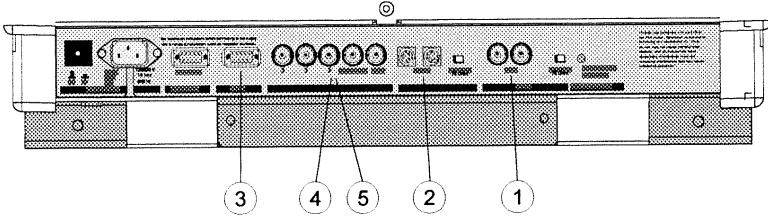

Source No	Projector input	Press Digit Button
1	Comp. Video	1
2	S-Video*	2
3	Analog	3
4	RGsB**	4
5	RGSB***	5
4	RG3sB****	6
5	RGB3S*****	7

Only available when the optional Tri-level sync module is installed.

- * Input signal Y/C (luma/chroma)
- ** Input signal : R, G and B with composite sync on G
- *** Input signal : R, G and B with separate composite or with separate Hor and Vert. sync.
- **** Input signal : R, G and B with Tri level sync on G sync.
- ***** Input signal : R, G and B with separate composite Tri level sync or with separate Hor and Vert. Tri-level sync.

CONNECTIONS

Connecting a Composite Video source to port 1.

Composite video signals from a VCR, OFF air signal decoder, etc..

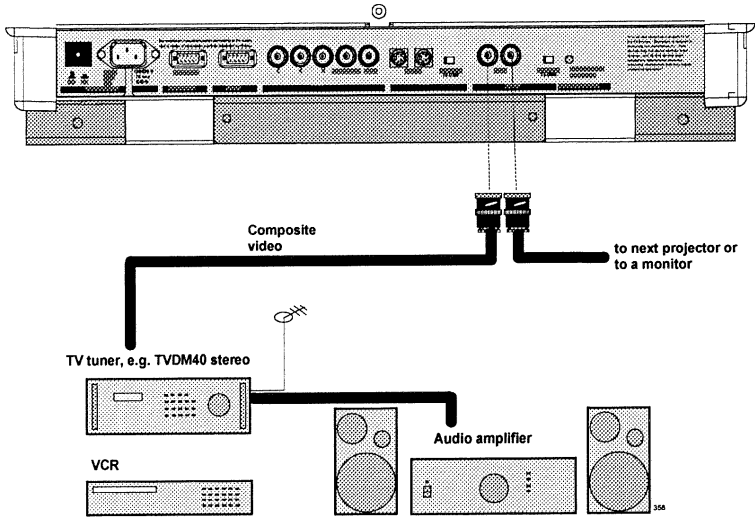

Video input selection :

with the RCU or the build in RCU : press digit button 1

* Note : if using the loop-through Video output, then set the Termination Switch to the "OFF" position.

Connecting a S-Video source to port 2.

Separate Y-luma/C-chroma signals for higher quality playback of Super VHS signals.

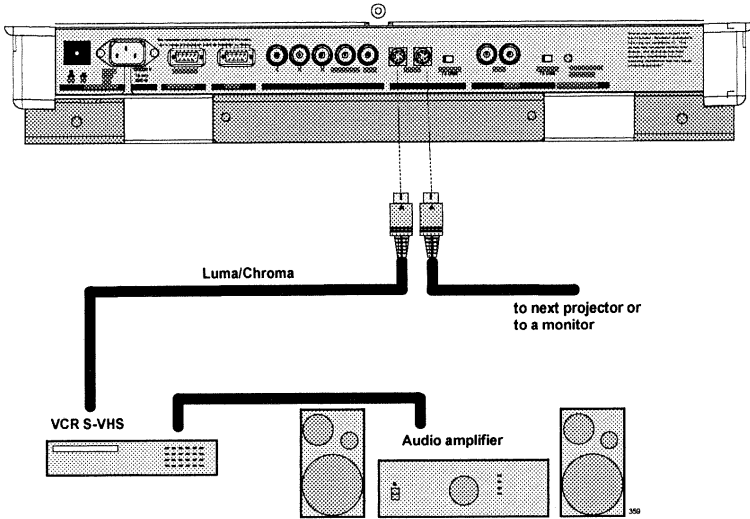

S-Video input selection

with the RCU or the build in RCU : press digit button 2

* Note: When using the S-Video loop-through output, set the Termination Switch in the "OFF" position.

CONNECTIONS

Connecting a RGB Analog source to port 3.

Connect your Analog source via an interface to Port 3. (e.g. RGB 120MHz Analog Interface, part number 98 26570).

RGB analog input with automatic sync detection. (Separate H and V sync inputs, with composite sync input or with sync signals on green)

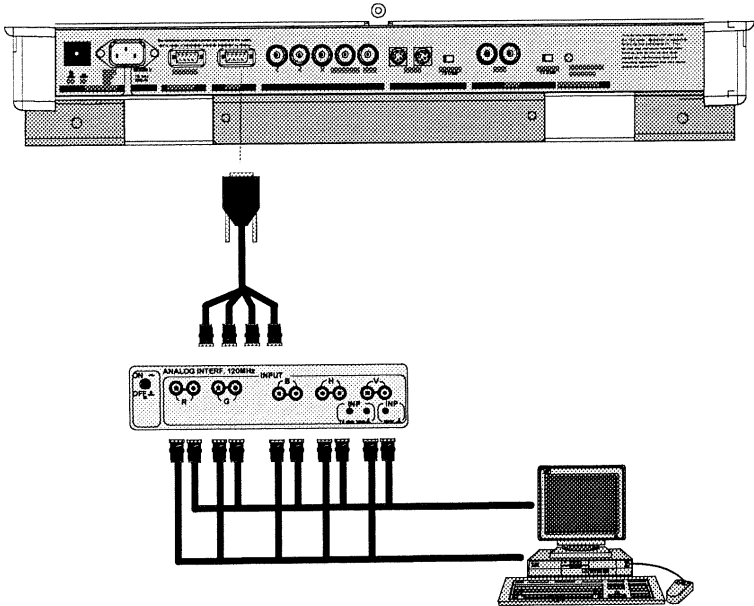

Pin configuration D9 connector of the Analog input.

- 1 not connected
- 2 ground RGBS
- 3 RED
- 4 GREEN
- 5 BLUE
- 6 ground RGBS
- 7 ground RGBS
- 8 Hor/comp. sync
- 9 Vert. sync

Analog Input Selection :
with the RCU or build in RCU, press digit button 3.

Connecting a RGB Analog source to port 4/5.

RGB analog input terminals with separate H and V sync inputs, with composite sync input or with sync signals on green.

Always use an interface when a computer and local monitor have to be connected to the projector. For example :

- Universal Analog Interface. Order number : R9826100.
- RGB 120 MHz Analog Interface. Order number : R9826570.

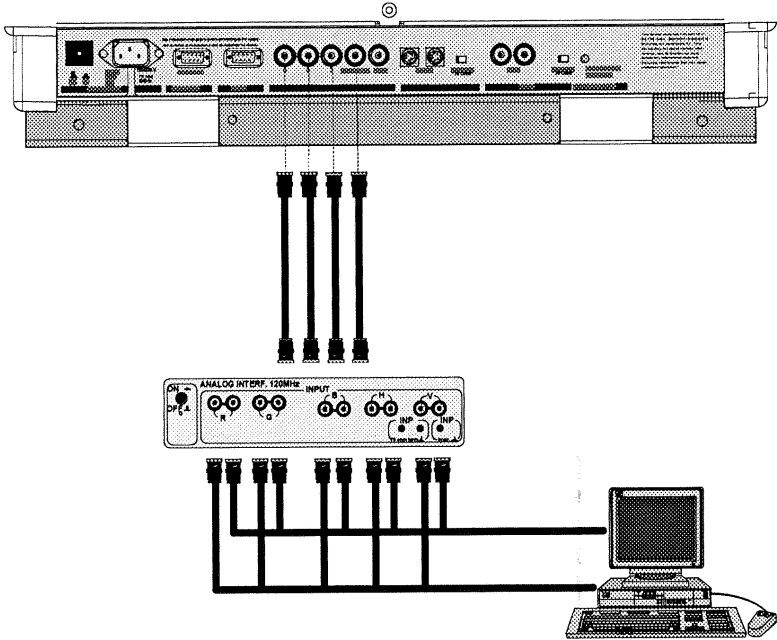

RGsB input selection :

(RGsB : R, G, B signals with sync on green)

with the RCU or the build in RCU : press digit button 4

RGBS input selection :

(RGBS : R, G, B and separate sync; H- and V- sync or comp. sync)

with the RCU or the build in RCU : press digit button 5

CONNECTIONS

Connecting a RGB Analog source with Tri-level sync to port 4/5. (option)

RGB analog input terminals with Tri level sync input or with Tri-level sync on green.
The projector detects automatically where the sync signal is located.

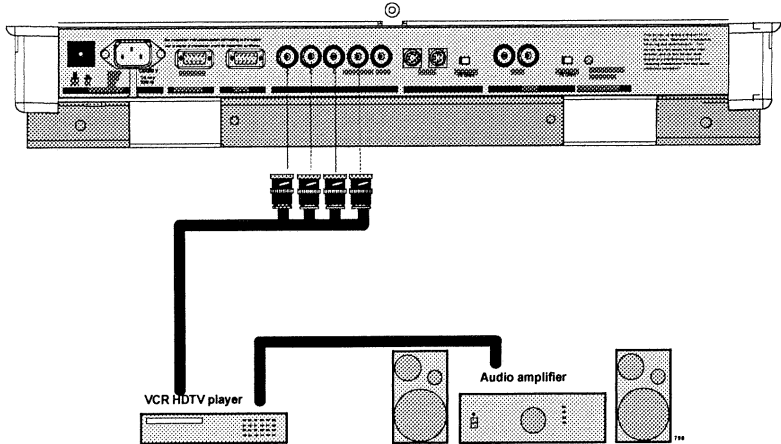

RGsB input selection :

(RG3sB : R, G, B signals with Tri-level sync on green)

with the RCU or the build in RCU : press digit button 6

RGBS input selection :

(RGB3S : R, G, B and Tri-level separate sync; H- and V- sync or comp. sync)

with the RCU or the build in RCU : press digit button 7

PERIPHERAL EQUIPMENT

Connecting a RCVDS 800 switcher or RCVDS 05 switcher to the BARCODATA 808

- Up to 10 inputs with one RCVDS 800 switcher or 20 inputs with the RCVDS 05 switcher and up to 90 inputs when 10 RCVDS switchers are linked via the expansion modules.
- Serial communication with the projector.
- Remote control buttons on the RCVDS to control the BARCODATA 808 (source selection and analog settings)
- The selected source number will be displayed on a 2 digit display and the selected input modules will be indicated with a LED on the rear.

For more information about the use of :

RCVDS 800, consult the RCVDS 800 Owner's Manual, order number: R5975004.

RCVDS 05, consult the RCVDS 05 Owner's Manual, order number : R5975765.

Connecting a VS05 switcher to the BARCODATA 808.

The VS05 can switch up to 5 Composite Video sources, 3 S-Video Sources and 1 RGB analog or component Video source to the BARCODATA 808. In addition, an audio signal associated with the source, can be switched to an audio amplifier. Order number : R9827890.

For more information about the use of the VS05, consult the VS05 Owner's Manual, order number : R5975245.

Connecting an IR Remote Receiver to the BARCODATA 808

This infra-red receiver unit makes it possible to control the BARCODATA 808 from another room. There is a communication line cable between the IR receiver and the projector or the RCVDS 800. The infrared control information from the Remote Control Unit is sent to the IR Remote Receiver. The IR Remote Receiver 800 displays the selected source on a 7-segment display. Order number : R9827515.

CONTROLLING THE PROJECTOR WITH THE REMOTE CONTROL UNIT (RCU)

Battery installation in the RCU

How to use your RCU

Projector address

How to display a projector address

How to program an address into the RCU

Input selection

Picture controls

Controlling chained projectors

Caution : Do not display a stationary image with full brightness and contrast for longer than 20 min., otherwise you risk damage to the CRT's.

Battery installation in the RCU.

A new battery (not yet installed to save the battery life) is delivered inside the plastic bag with the power cord. Before using the RCU, follow the battery installation procedure.

Remove the battery cover on the backside of the RCU by pushing the indicated handle a little to the bottom of the RCU. Lift up the top side of the cover at the same time (fig. 1).

Insert the new 9 V battery (type block E, e.g. 6F22S or equivalent) in the lower compartment and connect the battery to the contact plate.

Insert the battery into the lower compartment and put the cover back.

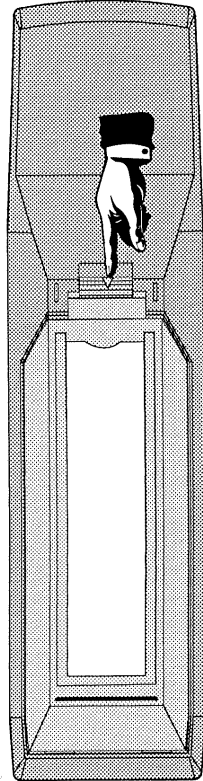

fig. 1

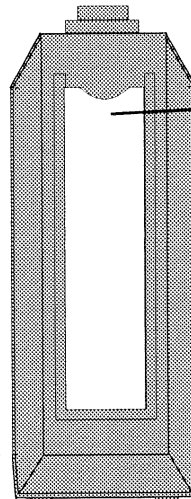
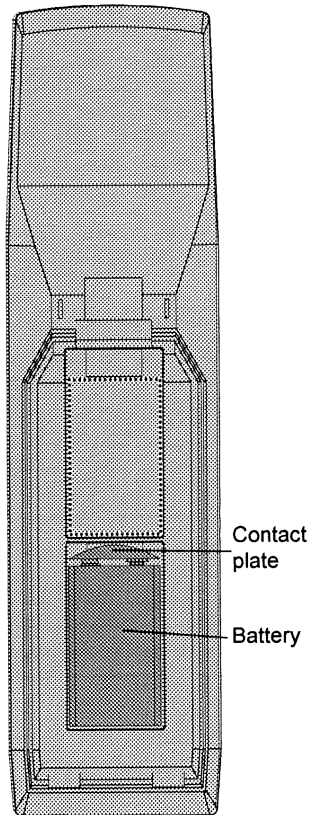

fig. 2

310a DRW

CONTROLLING

The BARCODATA 808 can be controlled with

- a. the RCU
- b. the hardwired RCU (cable not included)
- c. the built-in RCU (local keypad)

The procedure and results of controlling the projector with either of these RCU options is essentially the same.

How to use the RCU

- a) Point the front of the RCU towards the reflective screen surface

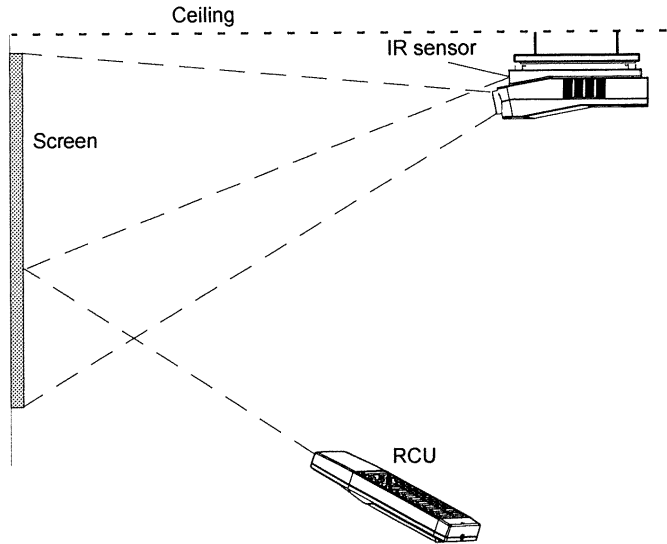

- b) Point the front of the RCU towards one of the IR sensors in the projector.

When using the wireless remote control, make sure you are within the effective operating distance (30m, 100ft in a straight line). The remote control unit will not function properly if strong light strikes the sensor window or if there are obstacles between the remote control unit and the projector's IR sensor.

IR Receiver Locations on the Projector:

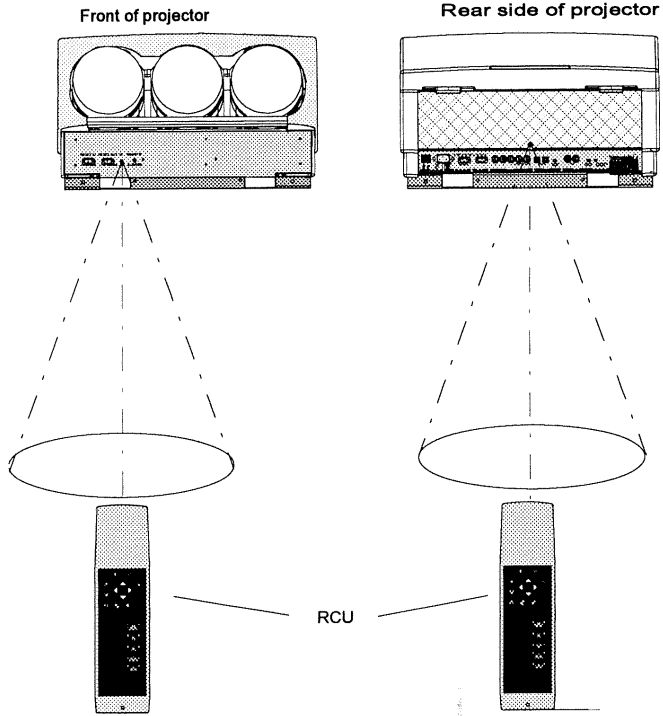

c) RCU used in a hardwired configuration.

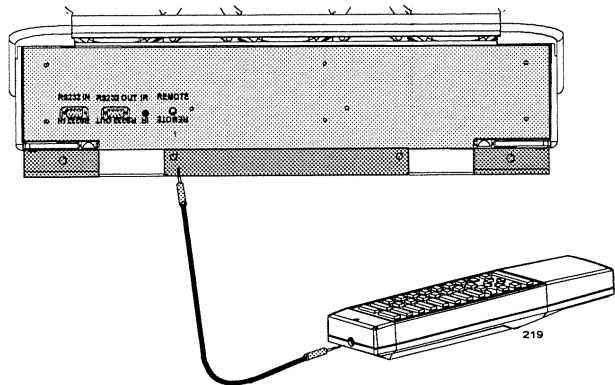

Plug one end of the remote cable in the connector on the bottom of the RCU and the second side in the connector in the rear panel of the BARCODATA 808 labelled 'REMOTE'.

d) Built-in RCU (local keypad)

To gain access to the built-in RCU, see paragraph 'The local keypad' on page 16.

Projector Address

a. hardware set up of the projector address.

Every projector requires an individual address between 0 and 255 which is set with hardware DIP switches inside the projector. To change that address, contact a BARCO authorized technician.

b. How to control the projector.

The projector's address may be set to any value between 0 and 255. When the address is set, the projector can be controlled now with :

- the RCU for addresses between 1 and 9.
- computer, e.g. IBM PC (or compatible), Apple MAC, etc. for addresses between 0 and 255.

Note : a projector will respond to a RCU set to an address of '0' regardless of what address is set in the projector itself. Address "0" is therefore a universal address.

c. Using the RCU.

Before using the RCU, it is necessary to enter the projector address into the RCU (only when that address is between 1 and 9). The projector with the corresponding address will listen to that specific RCU.

When address 0, 'zero address' is programmed into the RCU, every projector, without exception will listen to the commands given by this RCU.

How to display a projector address?

Press the ADDRESS key (recessed key on the RCU) with a pencil.

The projector's address will be displayed in a 'Text box'. This text box disappears after a few seconds.

To continue using the RCU, it is necessary to enter the same address with the digit buttons (address between 0 and 9). For example, if the Address Key displays projector address 003, then press the "3" digit button on the RCU to set the RCU's address to match the projector's address.

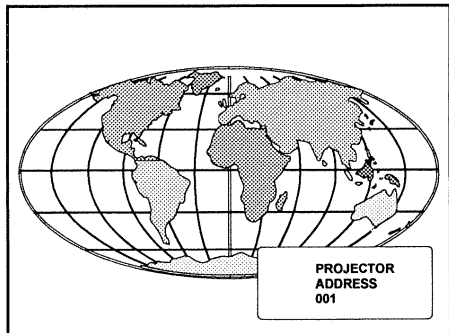

How to program an address into the RCU?

Press the ADDRESS key (recessed key on the RCU) with a pencil and enter the address with the digit buttons. That address can be any digit between 0 and 9. When programming '0', zero address, the RCU will control a projector regardless of the projector's address. This feature allows multiple projectors with different addresses to be controlled by a single RCU.

Input selection

Source No	Projector input	Press Digit Button
1	Comp. Video	1
2	S-Video*	2
3	Analog	3
4	RGsB **	4
5	RGBS***	5
4	RG3sB****	6
5	RGB3S*****	7

With the digit buttons on the RCU, it is possible to select input sources, Video, S-Video, RGsB or RGBS, RG3sB or RGB3S.

- * Input signal Y/L (luma/chroma)
- ** Input signal: R, G and B with composite sync on G
- *** Input signal: R, G and B with separate composite or with separate Hor and Vert. sync.
- **** Input signal: R, G and B with Tri level sync on G
- ***** Input signal: R, G and B with separate composite Tri level sync or with separate Hor and Vert. Tri-level sync.

CONTROLLING

When a valid and available source is selected, there will be information displayed on the screen about that source (if "Text" is on). This information includes :

- source number
- horizontal frequency
- vertical frequency

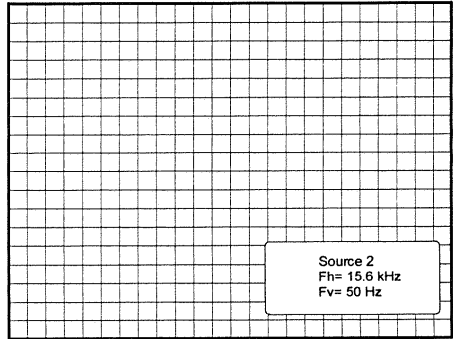

When the entry is a non valid source number, a warning appears on the screen : *'input not available'*.

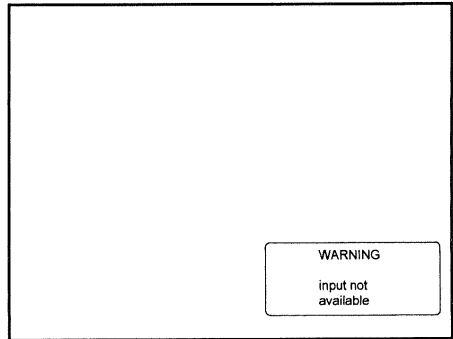

When a valid source number is selected, the projector will display this source or it will wait on the selected source number until the source becomes available. A message 'source not available' will be displayed for a short time.

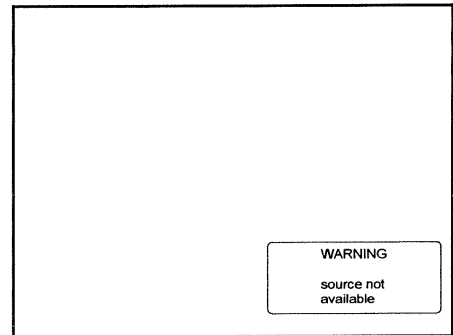

Analog Picture Controls

The analog picture controls can be adjusted with the RCU. The control keys are located on the lower right side of the key panel of the RCU and indicated with the name of the control and an icon.

When an analog picture control is pressed, a text box with bar scale and the function name of the control, e.g. 'brightness...' appears on the screen (only if 'TEXT' is ON). The length of the bar scale indicates the current memorized setting for this source. The bar scale changes as the + or - buttons of the control are pressed. The analog picture controls can be adjusted with the RCU in 'Adjustment' mode as well in 'Operational' mode.

Brightness Control

A correct 'brightness' setting is important for good image reproduction. Adjust the brightness with the + button and - button (RCU) until the darkest parts of the picture appear black.

A bar scale gives a visual indication on the screen of the current brightness setting while pressing on the above indicated keys. If the bar scale is not visible on the screen, press 'TEXT' key once and retry the above indicated keys.

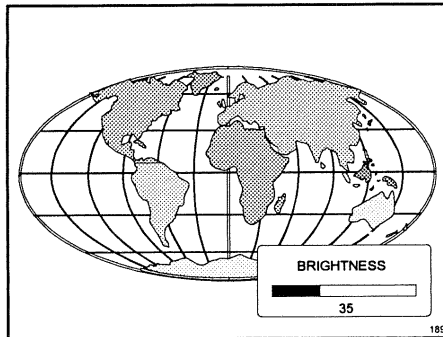

The bar scale increases when pressing on the + button (higher brightness) and decreases when pressing on the - button (lower brightness).

Contrast Control

A correct 'contrast' setting is important for good image reproduction. Adjust the contrast to the level you prefer, according to room lighting conditions. If the Contrast Control is too low, the picture will be too dim. If it is set too high, the picture may be too bright and not sharp.

A bar scale gives a visual indication on the screen of the current contrast setting while pressing the + or - buttons (RCU). If the bar scale is not visible on the screen, press

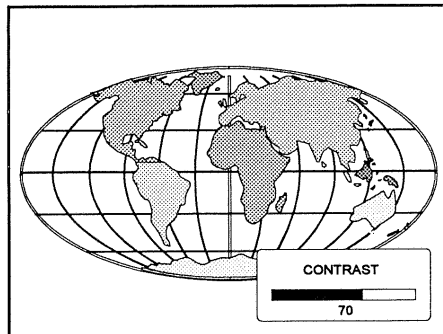

'TEXT' key once and retry the above indicated keys.

The bar scale increases when pressing on the + button (higher contrast) and decreases when pressing on the - button (lower contrast).

CONTROLLING

Color Saturation Control

Color saturation is only active for Video and S-Video Inputs. This control adjusts the color intensity of the picture. Adjust the color saturation using the + and - buttons (RCU). A bar scale gives a visual indication on the screen of the current color setting while pressing on the above indicated keys. If the bar scale is not visible on the screen, press 'TEXT' key once and retry the above indicated keys. The bar scale increases when pressing on the +

button (richer colors) and decreases when pressing the - button (lighter colors).

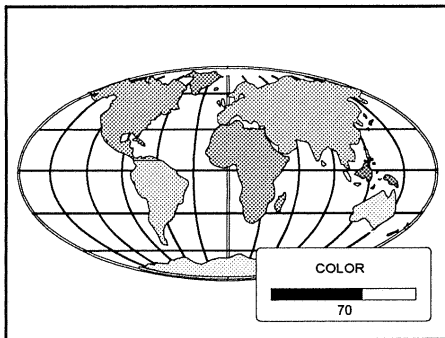

Tint Control

Tint is only active for Video and S-Video Inputs. The Tint Control is effective only when using the NTSC 4.43 or NTSC 3.58 system. A bar scale gives a visual indication on the screen of the current tint setting while pressing the + or - buttons (RCU). If the bar scale is not visible on the screen, press the 'TEXT' key once and retry the above indicated keys buttons.

The bar scale increases when pressing on the + button (greener flesh tones)

and decreases when pressing the - button (redder flesh tones).

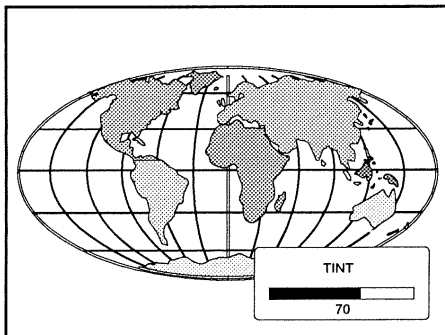

Sharpness Control.

Sharpness control only active for Video and S-Video Inputs. A bar scale gives a visual indication on the screen of the current sharpness setting while pressing the + or - buttons (RCU). If the bar scale is not visible on the screen, press 'TEXT' key once and retry the above indicated keys.

The bar scale increases when pressing on the + button (sharper picture) and decreases when pressing on the - button (softer picture).

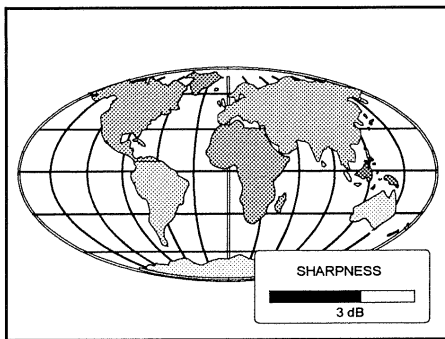

Controlling chained projectors.

Projectors can be controlled individually as well as in a group.

For individual control see previous pages.

For group control of the projectors.
(input selection and analog picture control)

Program the 'zero address' into any RCU. Therefore, press on the address key and key in the address ("0") with the numeric keys on the RCU itself.

Once address '0' is pressed, all projectors will be controlled together until a new address is entered on the RCU. It is possible to have a common input selection and a common analog picture control.

Once a new address is entered, only the projector with that specific address will follow the new instructions.

Note : For group control, all projectors in a control group must be capable of receiving the IR signal from the controlling RCU at the same time.

START UP OF THE ADJUSTMENT MODE

START UP OF THE ADJUSTMENT MODE

START UP OF THE ADJUSTMENT MODE

START UP OF THE ADJUSTMENT MODE

Entering the adjustment mode

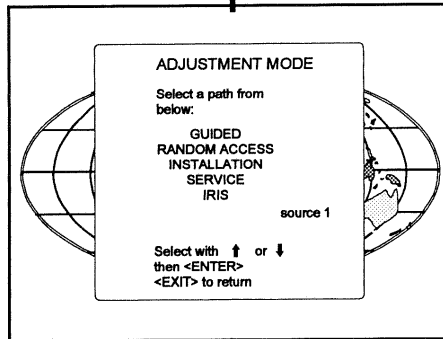
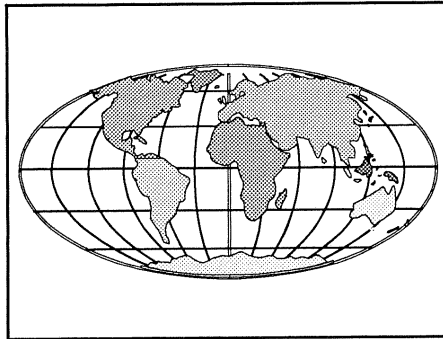

Installation
(only for qualified technicians)

Random Access Adjustment

Guided Adjustment

Service

IRIS
(only with an IRIS800)

START UP OF THE ADJUSTMENT MODE

START UP OF THE ADJUSTMENT MODE

Adjustment Mode

All picture geometry and convergence adjustments are made while in the 'Adjustment mode'. Press the ADJUST key to enter the 'adjustment mode'.

You are now in the 'Adjustment mode'. The **Joy stick** key is used to make menu selections and also vertical and horizontal adjustments. The **ENTER** and **EXIT** keys are used to move forward and backward through the menu structure. The **ADJUST** key can be used to terminate the adjustment mode while any path selection menu is displayed.

When an adjustment menu is displayed on the screen and no action is taken within the first 5 minutes, the projector will automatically reduce the brightness and contrast to a level so that the stationary image cannot damage the tubes.

There are 5 possible paths to follow once in the Adjustment mode. They are :

INSTALLATION - Installation should be selected if the projector has been relocated and/or a different screen size is desired. When selecting 'Installation', the user or operator will be warned to call a qualified technician to perform the installation procedure (see example of projected warning on the next page)

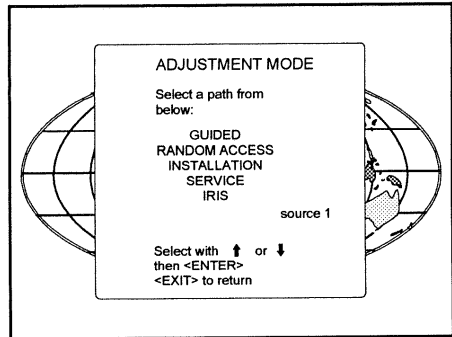

GUIDED - Guided should be selected if the user intends to perform a complete alignment of the projected image. All of the necessary geometry and convergence adjustments are made in a predetermined sequence.

RANDOM ACCESS - Random Access should be selected if the user intends to make only a few adjustments.

SERVICE - Service should be selected if the user intends to delete blocks, change password, select service adjustments or get set-up information.

IRIS - This selection will only be available when the IRIS Auto-Convergence unit is connected to the projector.

While in Guided or Random Access adjustment Modes, the user may use an external source, an internally generated genlocked pattern or an internally generated multifrequency cross hatch pattern as a setup pattern.

START UP OF THE ADJUSTMENT MODE

Warning during the start up of the installation mode.

WARNING
RISK OF ELECTRICAL SHOCK
NO USER ADJUSTABLE PARTS
INSIDE

THE FOLLOWING
INSTALLATION MENUS
ARE RESERVED TO,
AND TO BE PERFORMED ONLY
BY BARCO PERSONNEL, OR
BARCO AUTHORIZED DEALERS
IF QUALIFIED, PRESS
<ENTER> TO CONTINUE, OR
IF NOT, <EXIT> TO RETURN.

Some items in the Adjustment mode are password protected. While selecting such an item, the projector asks you to enter your password. (Password protection is only available when the password DIP switch on the controller module is in the ON position. Contact a BARCO authorized technician when no password is requested during the adjustment procedure and password protection is desired.)

Your password contains 4 digits.

Enter the digits with the numeric keys on the RCU.

Example : 2 3 1 9

For each digit entered, a 'X' appears on the screen under the displayed text 'enter password'.

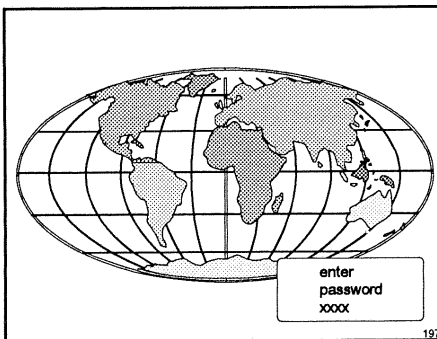

When your password is correct, you get access to the 'Adjustment item'.

When the entered password is wrong, The message 'Wrong password !!!' will be displayed. The projector stays on the previous selected item.

Factory programmed password :

0000

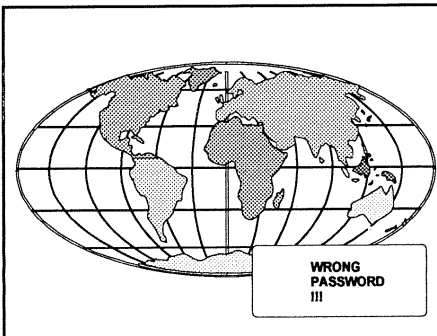

Once the password is correctly entered, all other password protected items are accessible without re-entering your password.

When re-entering the Adjustment mode, it will be necessary to enter your password again when selecting a password protected item.

GUIDED ADJUSTMENT MODE

Start-Up of the Guided Adjustment Mode.

Push the control stick forward or backward to highlight the *GUIDED* menu and then press **ENTER**.

The Guided Adjustment mode is password protected (when the password function is active). Enter your password to continue (see also chapter Start up of the Adjustment mode)

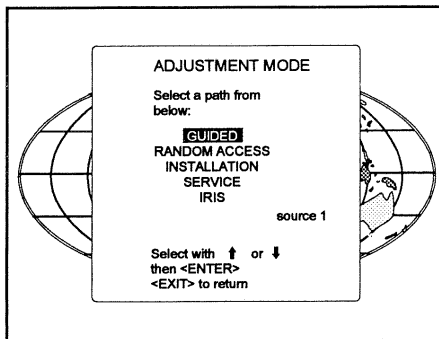

ENTER continues to the password menu and then to Setup Pattern Selection
EXIT returns to Operational mode.

Each time an adjustment is selected and adjusted with the control stick on the RCU, a text box appears on the screen with the adjustment name inside the box. A bar scale and number indicator between 0 and 100 in the same text box will give an indication of the adjustment.

GUIDED ADJUSTMENT MODE

Overview flowchart 'Guided Adjustment' procedure.

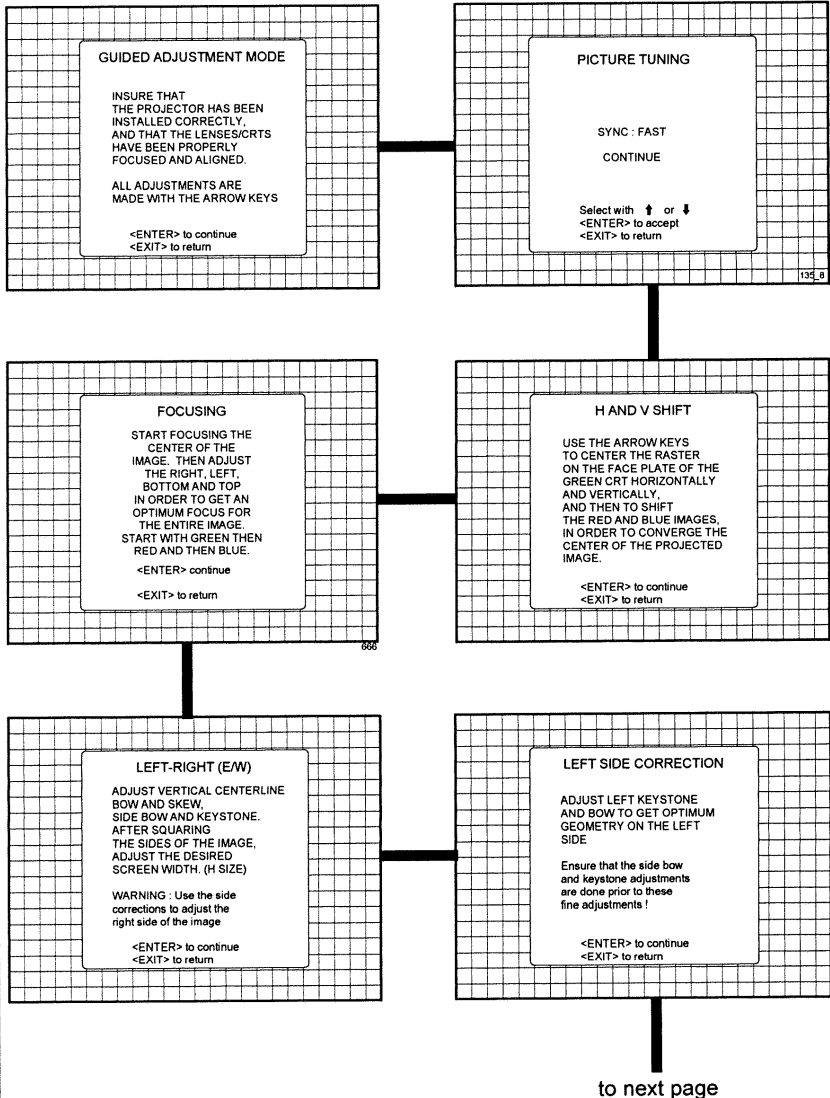

GUIDED ADJUSTMENT MODE

from previous page

TOP-BOTTOM

ADJUST HORIZONTAL CENTERLINE BOW AND SKEW, TOP BOW AND KEYSTONE, BOTTOM BOW AND KEYSTONE.

<ENTER> to continue
<EXIT> to return

SIZE-LINEARITY

ADJUST VERTICAL SIZE AND LINEARITY, IN ORDER TO ADJUST THE DESIRED IMAGE DIMENSIONS.

USE THE H PHASE CONTROL TO SHIFT THE IMAGE WITH RESPECT TO THE RASTER.

<ENTER> to continue
<EXIT> to return

BLANKING

ADJUST THE TOP, BOTTOM, LEFT AND RIGHT BLANKING IN ORDER TO FRAME THE PROJECTED IMAGE ONTO THE SCREEN.

THIS PROCEDURE WILL CONCLUDE THE GUIDED ADJUSTMENT SEQUENCE.

<ENTER> to continue
<EXIT> to return

CONVERGENCE

START WITH GREEN ONLY, THEN RED ON GREEN, THEN BLUE ON GREEN. USE THE ARROW KEYS FOR HORIZONTAL AND VERTICAL ADJUSTMENTS IN THE AREA INDICATED BY THE BOX.

<ENTER> WILL MOVE THE BOX TO THE NEXT AREA TO BE CONVERGED, AND <EXIT> WILL MOVE IT BACK TO THE PREVIOUS.

<ENTER> to continue
<EXIT> to return

COLOR BALANCE

FIXED COLOR BALANCE
3200 4900 6500 9300

CUSTOM WHITE BALANCE
CUSTOM BLACK BALANCE

CONTINUE

select with arrow keys then <ENTER>
You can adjust red with ↑ or ↓ and blue with ← or →
<EXIT> to return

602

GUIDED ADJUSTMENT MODE

Selecting Setup Pattern

If an external source is connected to the projector, the Setup Pattern menu will be displayed. Push the control stick forward or backward to highlight the desired setup pattern and then press **ENTER**.

Genlocked pattern : internally generated cross hatch pattern, locked on the external source.

Internal # pattern : internally generated cross hatch pattern and locked on internal generated sync signals. (No external source necessary)

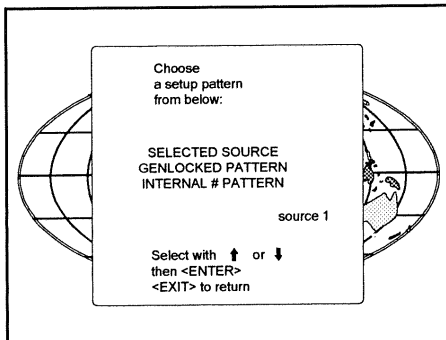

ENTER continues to Guided Adjustment Mode or Internal # Pattern Selection
EXIT returns to Path Selection
ADJUST returns to operational mode

If no external source is connected to the projector, the internal cross hatch pattern menu will be displayed.

Note: The menus in this manual are created for an external source, connected to one of the inputs, and the 'Genlocked pattern' is selected.

Internal Cross Hatch Pattern

The Internal # pattern menu will be displayed if the internal cross hatch pattern has been selected or if no source is connected to the projector.

The table below lists the 16 fixed factory preset frequencies available. Another 8 blocks are custom programmable.

Push the control stick forward or backward to highlight the desired cross hatch frequency. Use the left and right arrow to scroll to another page. Press **ENTER**, if the desired block is selected.

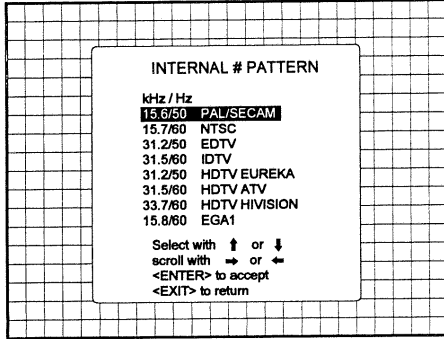

ENTER continues to Guided Adjustment Mode
EXIT returns to Setup Pattern Selection

kHz/Hz

15.6/50	PAL/SECAM
15.7/60	NTSC
31.2/50	EDTV
31.5/60	IDTV
31.2/50	HDTV EUREKA
31.5/60	HDTV ATV
33.7/60	HDTV HISION
15.8/60	EGA 1
21.8/60	EGA 2
31.5/70	VGA 1, 2
35.5/87	VGA 4
48.5/60	SUPER VGA 1
44.2/70	SUPER VGA 2
61.0/76	SUPER VGA 3
63.9/76	APOLLO
22.2/60	MAC CLASSIC

GUIDED ADJUSTMENT MODE

Note: Before continuing, insure that the lenses are properly focused and that the CRT projection angle is correctly adjusted. If any misalignment is noticed, consult a qualified service technician.

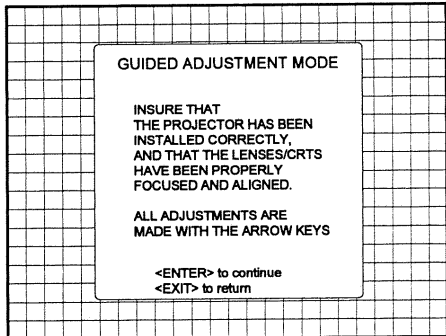

ENTER continues with the Picture Tuning
EXIT returns to Setup Pattern Selection or
Internal # Pattern Selection
ADJUST returns to operational mode

Picture tuning toggle switches.

Depending on the source type (video, S-Video, RGB(S) analog with composite or Tri-level sync) the picture tuning menu offers the possibility to toggle :

for Video or S-Video sources :

- the Synchronisation speed

for RGB analog or component input with composite or tri-level sync sources :

- enhanced blue on or off
- the Synchronisation speed

Sync Fast/Slow toggle

Highlight *Sync* with the control stick and press **ENTER** to toggle between FAST and SLOW

Note : SYNC is normally used in the SLOW position. The FAST position is used to compensate for unsteady sync pulses from older video playback equipment.

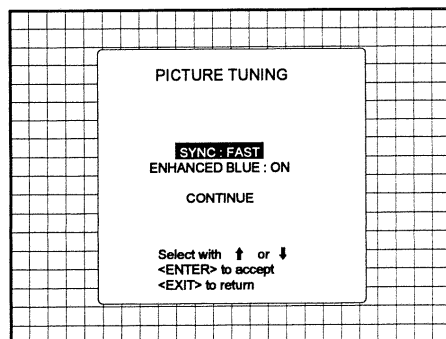

Enhanced Blue ON/OFF

Highlight *Enhanced Blue* by pushing the the control stick forward or backward and press **ENTER** to toggle between ON and OFF (only available when RGB analog signals are connected to the projector).

When Enhanced Blue is ON, the blue color will be displayed as cyan.

Note : Enhanced blue is only used when an RGBS or RGsB analog signal from a computer is being displayed. Enhanced blue is not recommended for non-computer generated images.

For displaying graphics, this Enhanced Blue function may falsify the color reproduction. In this case, put Enhanced Blue in the OFF position.

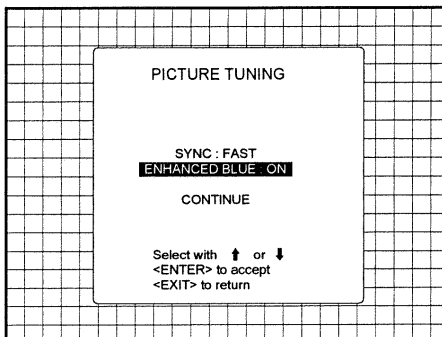

ENTER will toggle Enhanced Blue between ON and OFF.
EXIT will return to the guided start up menu.

Raster Centering on Green CRT Faceplate

The green raster must be centered both horizontally and vertically on the center of the CRT surface. To center the green raster, look into the green lens and use the arrow keys to move the raster.

Caution

It is necessary to look into the lenses to perform these adjustments. To avoid eye discomfort while looking into the lenses, reduce the contrast and gradually increase the brightness level until the raster becomes visible.

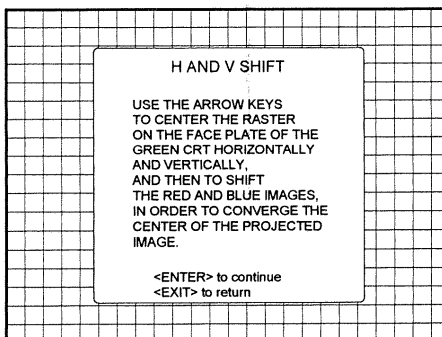

ENTER continues to Green Raster Shift
EXIT returns to the picture tuning menu
ADJUST returns to operational mode

GUIDED ADJUSTMENT MODE

Warning : In order to ensure maximum CRT longevity and to avoid CRT damage, do not shift the raster outside the phosphor area of the CRT.

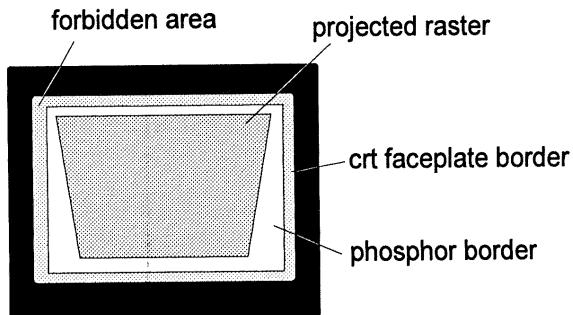

To begin the adjustment, press the **ENTER** key.

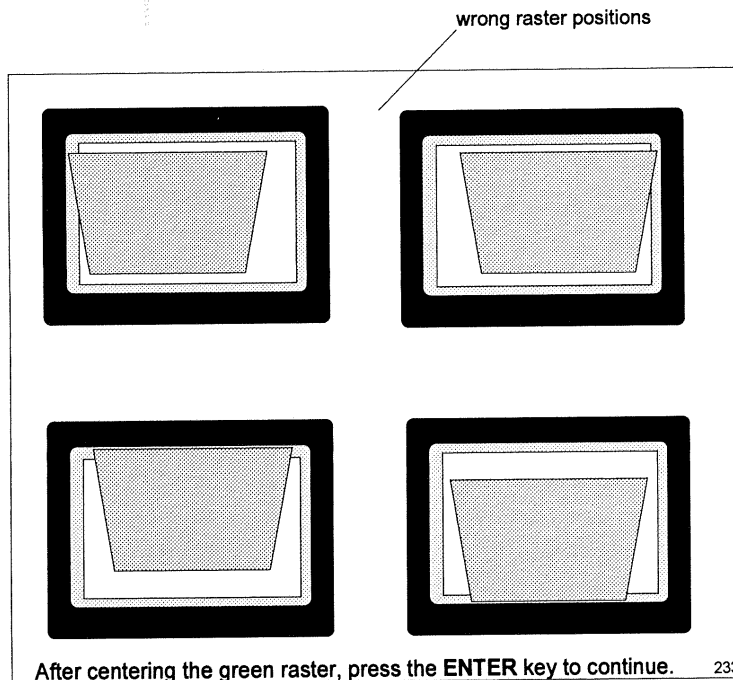

After centering the green raster, press the **ENTER** key to continue. 233

ENTER continues to Red Raster Shift
EXIT returns to Horizontal and Vertical Shift menu

Shifting Red and Blue on Green

Use the arrow keys to shift the red image until the center coincides with the center of the green image on the screen.

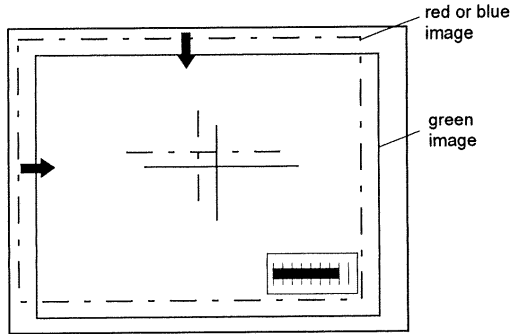

When the red image is correctly positioned, press the **ENTER** key to continue with the blue image.

ENTER continues to blue raster shift
EXIT returns to H and V shift menu

Focusing

Before starting the Focusing adjustment, be sure the lenses are correctly focused.

The software will guide you to adjust the following adjustments :

- Midpoint focusing
 - Top image focusing
 - Bottom image focusing
 - Left image focusing
 - Right image focusing
- First will be started with Green image, then with the Red and then with the Blue image.

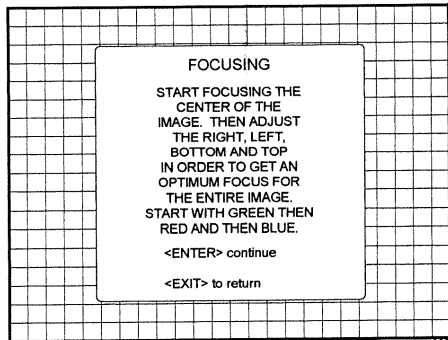

ENTER continues to the focusing adjustment.
EXIT returns to the shift adjustment.

GUIDED ADJUSTMENT MODE

GUIDED ADJUSTMENT MODE

Adjust by pushing the control stick to the left or to the right until the center of the image is sharp

Press **ENTER** to continue to the TOP image focusing.

Adjust in the same way for top image focusing (upper part of the image), bottom image focusing (lower part of the image), left image focusing (left part of the image) and right image focusing (right part of the image). Always press **ENTER** to go to the next part of the image which must be focused.

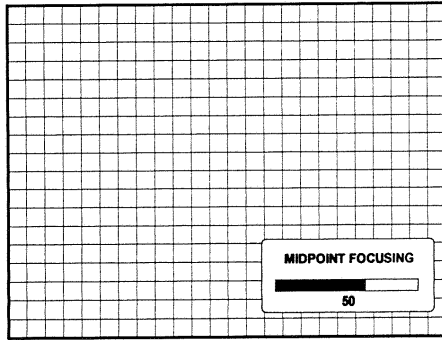

Left-Right (East-West) Adjustments

Left-right adjustments affect only the vertical lines of the setup pattern. Only the green image is displayed while making left-right adjustments. The red and blue images will automatically be corrected in the same manner.

Convergence corrections are automatically disabled for the duration of these adjustments.

Press the **ENTER** key to continue.

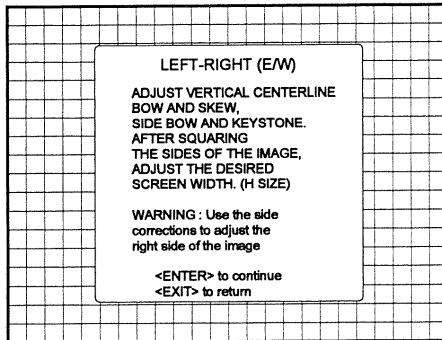

ENTER continues to Vertical Centerline Bow adjustment

EXIT returns to the Focusing menu

ADJUST returns to Operational mode

Vertical Centerline Bow Adjustment

The vertical centerline bow adjustment corrects for curvature in the horizontal direction in the middle of the picture for the vertical lines.

Push the control stick to the left or to the right to adjust the vertical centerline bow of the setup pattern and then press the **ENTER** key to continue to the Vertical Centerline Skew adjustment.

Press **EXIT** to return to the previous adjustment.



Correct by pushing the control stick to the right

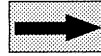

Vertical centerline



Correct by pushing the control stick to the left

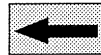

Vertical Centerline Skew Adjustment

The vertical centerline skew function corrects for tilting of the vertical lines in the middle of the picture.

Push the control stick to the left or to the right to adjust the vertical centerline skew of the setup pattern until this line is straight. Misalignment of the outer vertical lines will be corrected with the bow and key-stone corrections. Press **ENTER** to continue to the Side Bow adjustment.

Press **EXIT** to return to the previous adjustment..

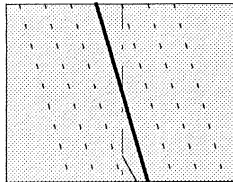

Correct by pushing the control stick to the right

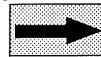

Vertical centerline

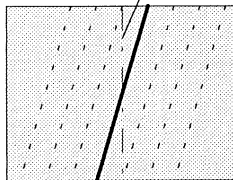

Correct by pushing the control stick to the left

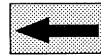

GUIDED ADJUSTMENT MODE

Side Bow Adjustment

The side bow function corrects for curvature of the vertical lines at the side of the displayed image. Look only to the right side of the image while adjusting this control.

Push the control stick to the left or to the right to adjust the side bow (right side) of the setup pattern (vertical lines) and press **ENTER** to continue to the Side Keystone Adjustment.

Press **EXIT** to return to the previous adjustment.

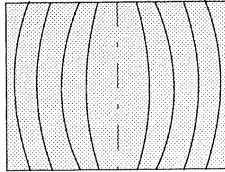

Correct by pushing the control stick to the right

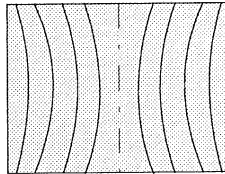

Correct by pushing the control stick to the left

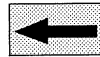

Side Keystone Adjustment

The side keystone function corrects the keystone geometry distortion of the vertical lines on the side of the image. Look only to the right side of the image while adjusting this control.

Push the control stick to the left or to the right to adjust the keystone (vertical lines) of the setup pattern and press **ENTER** to continue to the Seagull correction. Press **EXIT** to return to the previous adjustment.

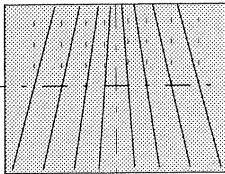

Correct by pushing the control stick to the right

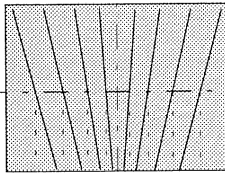

Correct by pushing the control stick to the left

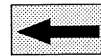

Seagull Correction

Use this correction only if still a 'S' deformation is visible on the left and the right side of the image after adjusting the vertical lines with the previous left-right corrections.

The default value on the bar scale for the seagull correction is 50. Eliminate the deformation by pushing the control stick to the right or to the left until the vertical lines at the edge of the image are straight.

ENTER continues to the Horizontal Size Adjustment.

EXIT returns to the Side Keystone adjustment.

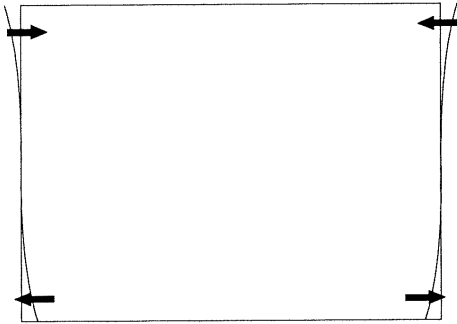

Left Side Correction

Left side corrections affect only the vertical lines of the set up pattern. Only the green image is displayed while making the left side adjustments. The red and blue images will automatically be corrected in the same manner.

Convergence corrections are automatically disabled for the duration of these adjustments.

Look only to the left side of the image while adjusting these fine tunings (bow and keystone). Before starting the left side correction, ensure that the side bow and keystone adjustments are done prior to these fine adjustments !

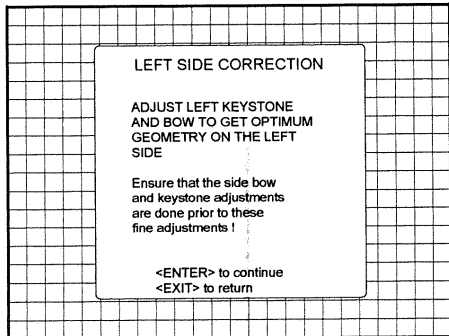

ENTER continues to the left keystone adjustment.

EXIT returns to the Left-Right adjustments.

ADJUST returns to Operational mode.

GUIDED ADJUSTMENT MODE

Left Keystone Correction

The left keystone correction is a fine adjustment of the keystone geometry distortion of the vertical lines on the left side of the image

Push the control stick to the right or to the left to adjust the keystone (vertical lines) of the setup pattern on the left side of the image and press **ENTER** to continue to the Left Bow correction.

Press **EXIT** to return to the previous adjustment.

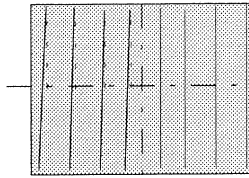

Correct by pushing the control stick to the right

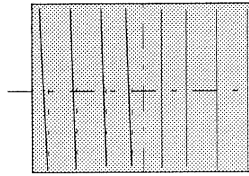

Correct by pushing the control stick to the left

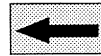

Left Bow Correction

The left bow correction is a fine adjustment of the curvature of the vertical lines on the left side of the image

Push the control stick to the right or to the left to adjust the bow (vertical lines) of the setup pattern on the left side of the image and press **ENTER** to continue to the Top-Bottom corrections.

Press **EXIT** to return to the previous adjustment.

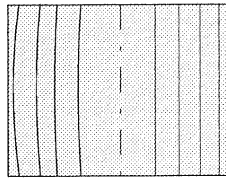

Correct by pushing the control stick to the right

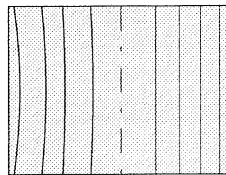
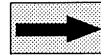

Correct by pushing the control stick to the left

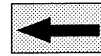

Horizontal Size Adjustment

Adjust the horizontal size by pushing the control stick forward or backward until the correct image width is obtained.

Note :

- if the internal # pattern was selected, this pattern remains on the screen.
- if the genlocked pattern was selected, the external source will be displayed.

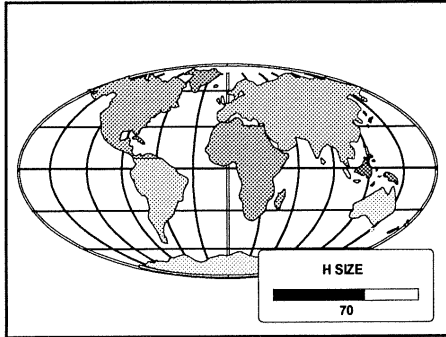

A bar scale and a numeric indicator (between 0 and 100) help to gauge the horizontal size adjustment.

ENTER continues to Top-Bottom adjustments

EXIT returns to side bow adjustments

Hint : In order to avoid loss of resolution in the projected image and to ensure maximum

CRT longevity, do not use an excessively small horizontal size setting. As the image size is also influenced by the distance from the screen to the projector, be sure to consult your dealer for the correct installation position of the projector.

H Size too Large

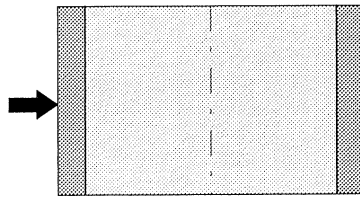

ideal image width

Correct by pushing the control stick to the right

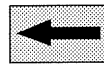

H Size too Small

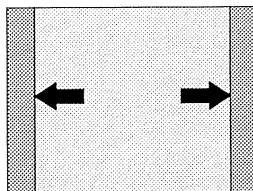

Correct by pushing the control stick to the left



GUIDED ADJUSTMENT MODE

Top-Bottom (North-South) Adjustments

Top-Bottom adjustments affect only the horizontal lines of the setup pattern. These adjustments are performed only on the green image. The red and blue images are automatically corrected in the same manner.

Convergence corrections are automatically disabled for the duration of these adjustments.

Press the **ENTER** key to continue.

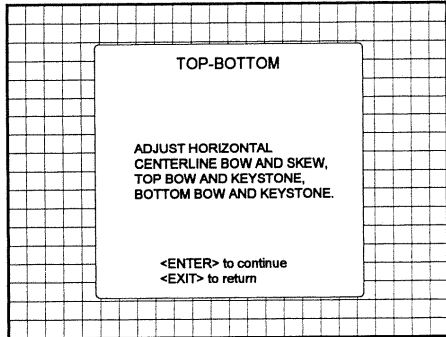

ENTER continues to horizontal centerline bow adjustment
EXIT returns to Left-Right adjustments menu
ADJUST returns to operational mode

Horizontal Centerline Bow Adjustment

The horizontal centerline bow function corrects for curvature of the horizontal lines in the vertical direction in the middle of the picture.

Push the control stick forward or backward to adjust the horizontal centerline bow of the setup pattern.

Press **ENTER** key to continue to the Horizontal Centerline skew adjustment.

Press **EXIT** to return to the previous adjustment.

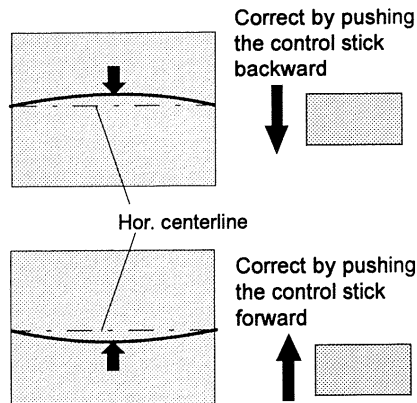

Horizontal Centerline Skew Adjustment

The horizontal skew function corrects for tilting of the horizontal lines in the middle of the picture.

Push the control stick forward or backward to adjust the horizontal centerline skew of the setup pattern.

Press **ENTER** key to continue to the Top Bow adjustment.

Press **EXIT** to return to the previous adjustment.

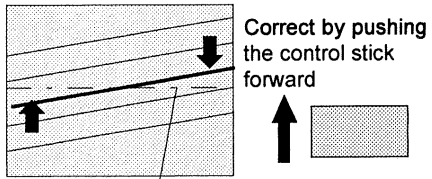

Hor. centerline

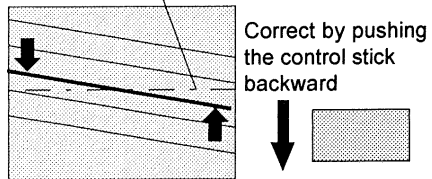

Top Bow Adjustment

The top bow function corrects for curvature occurring in the upper part of the image.

Adjust the bow of the horizontal lines in the upper side of the image by pushing the control stick forward or backward until these lines are straight.

Press **ENTER** to continue to the Top keystone adjustment.

Press **EXIT** to return to the previous adjustment.

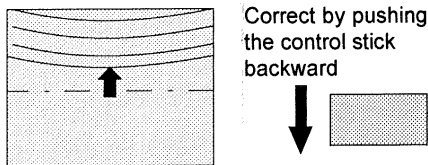
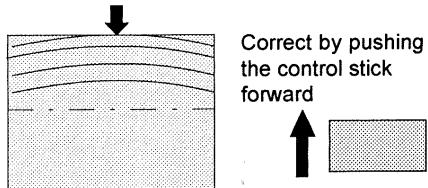

GUIDED ADJUSTMENT MODE

Top Keystone Adjustment

The top keystone function corrects for keystone geometry distortion of the horizontal lines in the upper part of the picture. Adjust the horizontal lines in the upper part of the picture by pushing the control stick forward or backward until these lines are straight. Press **ENTER** to continue to the Bottom Bow adjustment. Press **EXIT** to return to the previous adjustment.

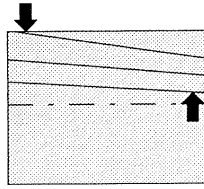

Correct by pushing the control stick forward

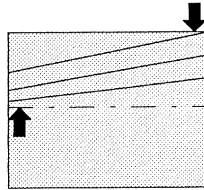
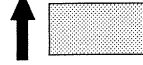

Correct by pushing the control stick backward

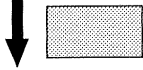

Bottom Bow Adjustment

The bottom bow function corrects for curvature occurring in the lower part of the image. Push the control stick forward or backward to adjust the bottom bow in the lower part of the setup pattern. Adjust until the horizontal lines are straight. Press **ENTER** to continue to the Bottom keystone adjustment. Press **EXIT** to return to the previous adjustment.

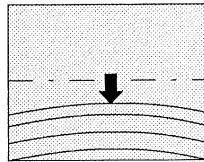

Correct by pushing the control stick forward

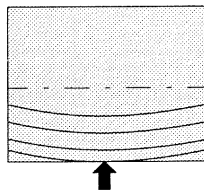
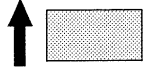

Correct by pushing the control stick backward

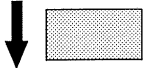

Bottom Keystone Adjustment

The bottom keystone function corrects for keystone geometry distortion of the horizontal lines in the lower part of the image.

Adjust the horizontal lines in the lower part of the image by pushing the control stick forward or backward until these lines are straight.

Press **ENTER** to continue to the Size-Linearity adjustment. Press **EXIT** to return to the previous adjustment.

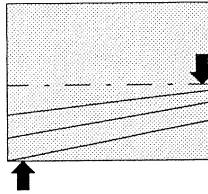

Correct by pushing the control stick forward

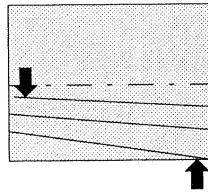
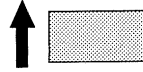

Correct by pushing the control stick backward

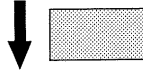

Seagull correction

Use this correction only if still a deformation (like a seagull) is visible on top and bottom of the image after adjusting the other top-bottom corrections.

The default value on the bar scale for the seagull correction is 50.

Eliminate the deformation by pushing the control stick to the right or to the left until the vertical lines at the edge of the image are straight.

Press **ENTER** to continue to the Size-Linearity adjustments. Press **EXIT** to return to the bottom keystone correction.

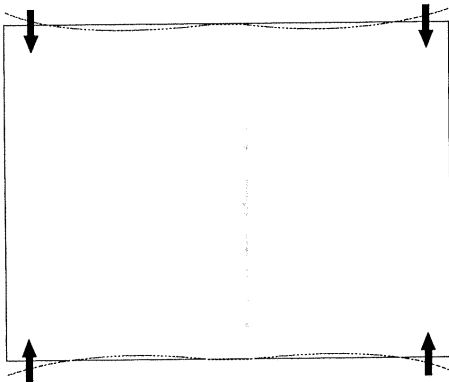

Size-Linearity Adjustment

Size adjustments affect the height and width of the projected image. The vertical linearity adjustment is used to adjust the horizontal lines of the setup pattern until the spacing between them is even. The horizontal phase adjustment is used to shift the image horizontally within the raster.

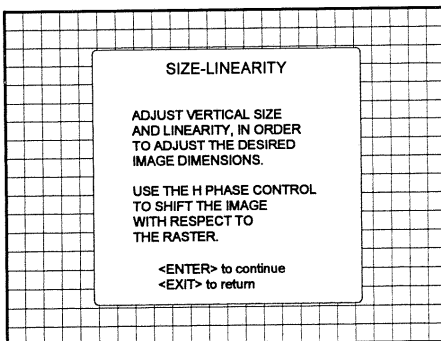

ENTER continues to Vertical linearity adjustment
EXIT returns to Top-Bottom adjustments Menu
ADJUST returns to operational mode

Vertical Linearity Adjustment

Adjust the vertical linearity by pushing the control stick forward or backward until the distance between the horizontal lines of the set up pattern are equal from top to bottom. Press **ENTER** key to continue to vertical size adjustment. Press **EXIT** key to return to the Size-Linearity menu.

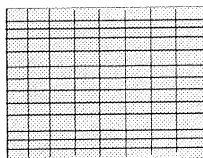

Correct by pushing the control stick forward

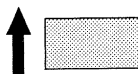

Correct by pushing the control stick backward



Vertical Size Adjustment

Adjust the vertical size by pushing the control stick forward or backward. Correct by pushing the control stick forward. Correct by pushing the control stick backward until the correct image height is obtained.

Note :

- if the internal # pattern was selected, this pattern remains on the screen.
- if the genlocked pattern was selected, the external source will be displayed.

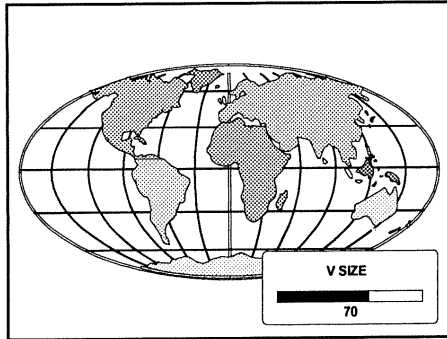

Hint :

In order to avoid loss of resolution in the projected image and to ensure maximum CRT longevity, do not use an excessively small vertical size setting.

ENTER continues to horizontal phase adjustment
EXIT returns to size-linearity menu.

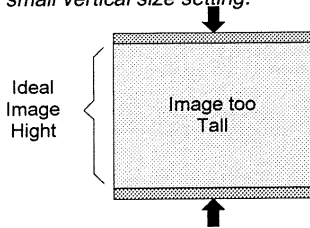

Correct by pushing the control stick backward

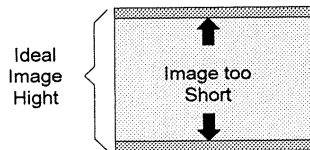
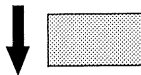

Correct by pushing the control stick forward

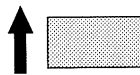

GUIDED ADJUSTMENT MODE

Horizontal Phase Adjustment

Note : No horizontal phase adjustment is available on the internal # pattern.

For external sources :
If the raster shift is correctly adjusted, the H. Phase text box is projected in the middle of the raster. At that moment, the "><" icon indicates the middle of the raster.

Adjust the H. Phase control until the middle of the projected image is equal with the middle of >< icon.

Note :

-if the genlocked pattern was selected, the external source will be displayed.

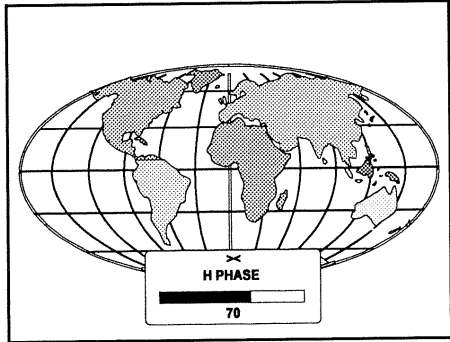

ENTER continues to Convergence
EXIT returns to the Size-linearity menu.

Correct by pushing
the control stick to
the left

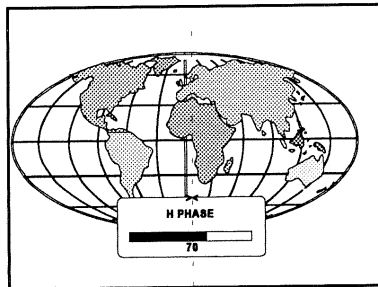

Correct by pushing
the control stick to
the right

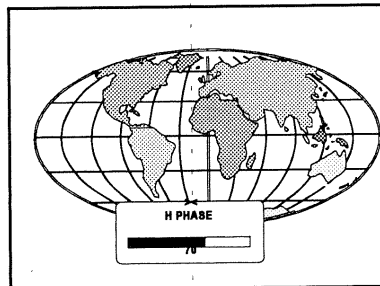

Convergence Adjustments

Convergence adjustments affect both the horizontal and vertical lines of the setup pattern. These adjustments are performed on the red image while superimposed on the green image and then on the blue image while superimposed on the green image.

The screen area is divided into 25 areas. Within each area it is possible to move the horizontal and vertical lines of the red and blue picture until they coincide with the green lines.

Use the control stick to make horizontal and vertical convergence adjustments in the area indicated by the box. Pressing ENTER will move the box to the next area of the setup pattern to be converged. Pressing EXIT will move the box back to the last area.

The 'guided adjustment' program will start with the convergence adjustment of the red picture on the green and continues with the blue image on the green image.

Attention : when green convergence adjustments are available (option). The control software starts with these green corrections (the menu will indicate it also). Adjust the green convergence controls until all vertical and horizontal lines are perfectly straight.

CONVERGENCE
 START WITH GREEN ONLY,
 THEN RED ON GREEN,
 THEN BLUE ON GREEN.
 USE THE ARROW KEYS FOR
 HORIZONTAL AND VERTICAL
 ADJUSTMENTS IN THE AREA
 INDICATED BY THE BOX.

<ENTER> WILL MOVE
 THE BOX TO THE NEXT AREA
 TO BE CONVERGED, AND
 <EXIT> WILL MOVE IT BACK
 TO THE PREVIOUS.
 <ENTER> to continue
 <EXIT> to return

ENTER continues to convergence adjustment
 EXIT returns to Size-Linearity adjustments
 ADJUST returns to operational mode.

25	23	9	15	17
24	22	8	14	16
5	4	1	2	3
20	18	6	10	12
21	19	7	11	13

397

GUIDED ADJUSTMENT MODE

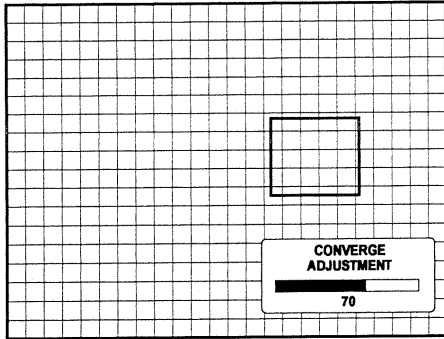
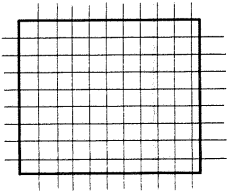
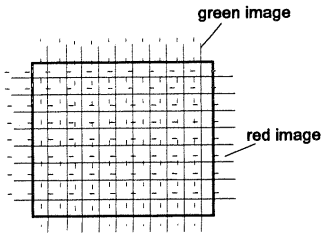

ENTER selects a new box and finally at the end it continues with the Blanking Adjustments.
EXIT returns to the last area.

Blanking Adjustments

Blanking adjustments affect only the edges of the projected image and are used to frame the projected image on to the screen and to hide or black out unwanted information (or noise). A 0% on the bar scale indicates no blanking.

The following blanking corrections are possible :

- top blanking
- bottom blanking
- left blanking
- right blanking

Note :

- if the internal # pattern was selected, this pattern remains on the screen.
- if the genlocked pattern was selected, the external source will be displayed.

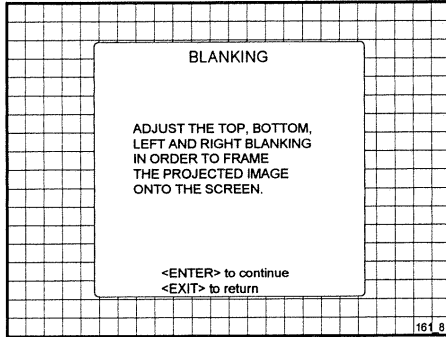

ENTER continues to top blanking adjustment.
EXIT returns to convergence menu
ADJUST returns to operational mode

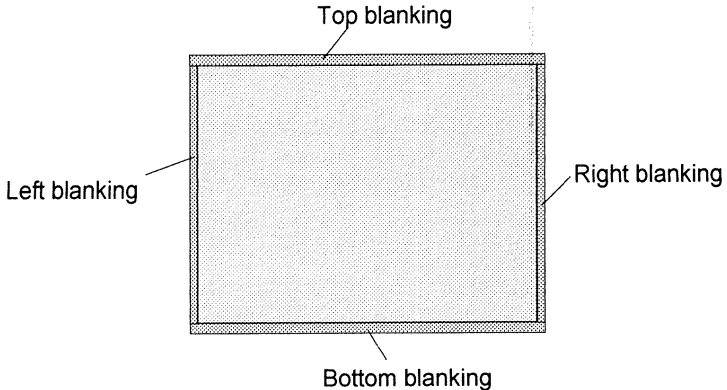

GUIDED ADJUSTMENT MODE

Top blanking adjustment

Push the control stick forward or backward to adjust the top blanking of the setup pattern. Press **ENTER** to continue to the Bottom Blanking adjustment. Press **EXIT** to return to the blanking menu.

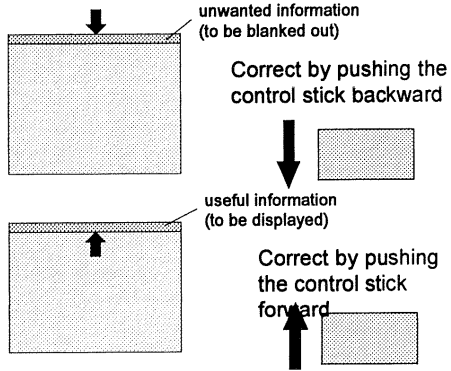

Bottom blanking adjustment

Push the control stick forward or backward to adjust the bottom blanking of the setup pattern. Press **ENTER** key to continue to left blanking adjustment. Press **EXIT** key to return to the blanking menu.

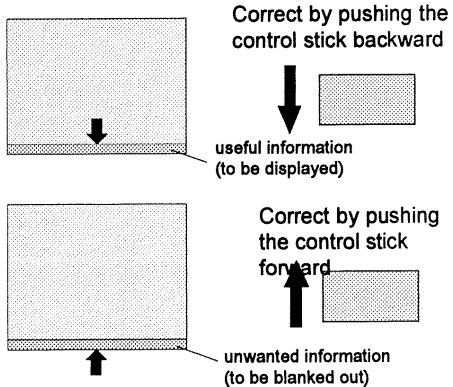

Left blanking adjustment

Push the control stick to the left or to the right to adjust the left blanking of the setup pattern. Press **ENTER** key to continue to the right blanking adjustment. Press **EXIT** key to return to the blanking adjustments menu.

unwanted information
(to be blanked out)

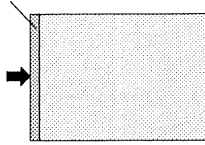

Correct by pushing the control stick to the right

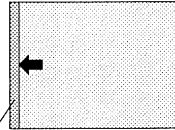
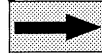

Correct by pushing the control stick to the left

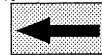

useful information
(to be displayed)

Right blanking adjustment

Push the control stick to the left or to the right to adjust the right blanking of the setup pattern. **ENTER** continues to the color balans menu. **EXIT** returns to blanking adjustments menu

unwanted information
(to be blanked out)

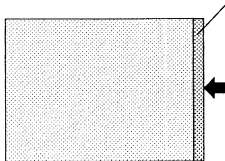

Correct by pushing the control stick to the right



Correct by pushing the control stick to the left

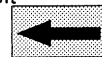

useful information
(to be displayed)

GUIDED ADJUSTMENT MODE

Color Balance

Use the control stick to select between :

- Fixed Color Balance (one of the 4 predefined values)
- Custom white balance
- Custom black balance.

Fixed Color Balance

4 color temperatures are pre-programmed :

- 3200 K (reddish)
- 4900 K
- 6500 K (white)
- 9300 K (bluish)

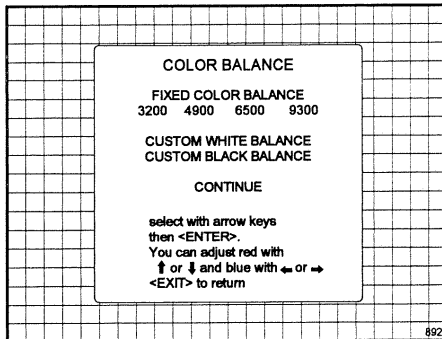

Select one of the 4 preprogrammed color temperatures with the control stick and press **ENTER** to display the desired color balance on the screen. Press **ENTER** again to continue.

Custom White Balance

Select custom white balance with the control stick and press **ENTER** to start the adjustment. Push the control stick forward or backward to adjust red gain and push the control stick to the left or to the right to adjust the blue gain. A bar scale indicates the amount of adjustment.

Custom Black Balance

Select custom black balance with the control stick and press **ENTER** to start the adjustment. Push the control stick forward or backward to adjust the red cut off and push the control stick to the left or to the right to adjust the blue cut off.

When the color balance is adjusted, select continue with the control stick and press **ENTER**.

RANDOM ACCESS ADJUSTMENT MODE

Starting up the random access adjustment mode

Overview flow chart 'Random Access Adjustment' mode

Selecting Setup Pattern

Internal Cross Hatch Pattern

Picture Tuning

Color Balance

Sync Fast/Slow

Enhanced Blue On/Off Adjustment

Color Select

Focusing

Geometry Adjustments

Horizontal phase

Raster shift adjustment

Left-right adjustments

Left side corrections

Top-Bottom adjustments

Horizontal size

Vertical linearity

Vertical size

Blanking adjustments

Convergence Adjustments

Starting-Up the Random Access Adjustment mode.

Push the control stick forward or backward to highlight "RANDOM ACCESS" and then press ENTER.

Some items in the Random access mode are password protected (when the password function is enabled). Enter your password to continue. All other password protected items are now also available if you stay in the adjustment mode.

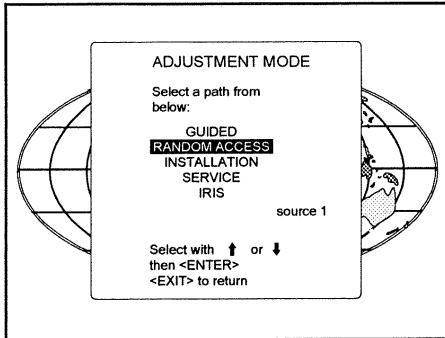

ENTER continues to Setup Pattern Selection
EXIT returns to Operational mode

RANDOM ACCESS ADJUSTMENT MODE

Overview flowchart 'Random Access Adjustment' mode

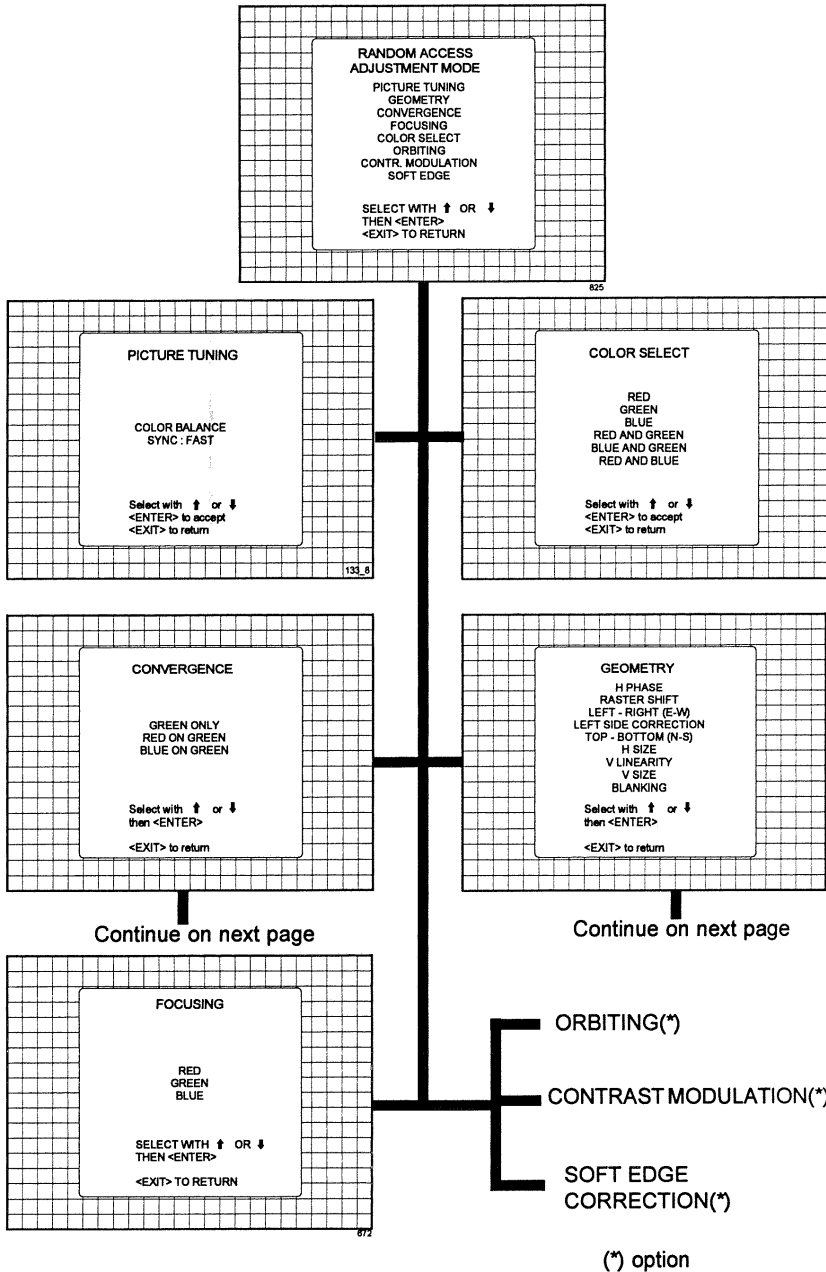

RANDOM ACCESS ADJUSTMENT MODE

RANDOM ACCESS ADJUSTMENT MODE

GEOMETRY

H PHASE
 RASTER SHIFT
 LEFT - RIGHT (E-W)
 LEFT SIDE CORRECTION
 TOP - BOTTOM (N-S)
 H SIZE
 V LINEARITY
 V SIZE
 BLANKING

Select with ↑ or ↓
 then <ENTER>

<EXIT> to return

LEFT-RIGHT

V CENTERLINE BOW
 V CENTERLINE SKEW
 SIDE BOW
 SIDE KEYSTONE
 SEAGULL CORRECTION

Select with ↑ or ↓
 then <ENTER>

<EXIT> to return

LEFT SIDE CORRECTION

LEFT KEYSTONE
 LEFT BOW

Ensure that the side bow
 and keystone adjustments
 are done prior to
 these fine
 adjustments !

Select with ↑ or ↓
 then <ENTER>

<EXIT> to return

TOP - BOTTOM

H CENTERLINE BOW
 H CENTERLINE SKEW
 TOP KEYSTONE
 TOP BOW
 BOTTOM KEYSTONE
 BOTTOM BOW
 SEAGULL CORRECTION

Select with ↑ or ↓
 then <ENTER>

<EXIT> to return

BLANKING

TOP
 BOTTOM
 LEFT
 RIGHT

Select with ↑ or ↓
 then <ENTER>

<EXIT> to return

CONVERGENCE

GREEN ONLY
 RED ON GREEN
 BLUE ON GREEN

Select with ↑ or ↓
 then <ENTER>

<EXIT> to return

CONVERGENCE

SEL : select area
 using
 arrow keys
 ADJ : adjust area
 using
 arrow keys

Toggle between
 SEL and ADJ
 with <ENTER>

<ENTER> continue
 <EXIT> to return

RANDOM ACCESS ADJUSTMENT MODE

Selecting Setup Pattern

If an external source is connected to the projector, this menu will be displayed. Push the control stick forward or backward to highlight the desired setup pattern and then press **ENTER**.

Genlocked pattern : internally generated cross hatch pattern, locked on the external source.

Internal # pattern : internally generated cross hatch pattern and locked on internal generated sync signals. (No external source necessary)

If no external source is connected to the projector, the internal cross hatch pattern menu will be displayed.

Note: The menus in this manual are created for an external source, connected to one of the inputs, and the 'Genlocked Pattern' is selected.

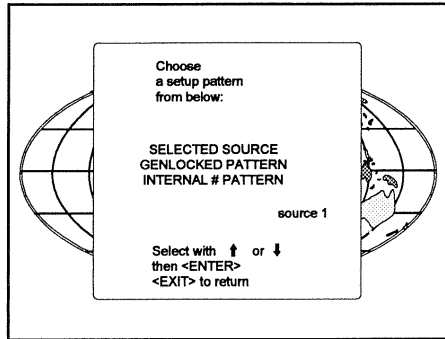

ENTER continues to Random Access Adjustment Mode or Internal # Pattern Selection
EXIT returns to Path Selection menu
ADJUST returns to Operational mode

Internal Cross Hatch Pattern

The Internal # pattern menu will be displayed if the internal cross hatch pattern has been selected or if no source is connected to the projector.

The table below lists the 16 fixed factory preset frequencies available. Another 8 blocks are custom programmable.

Push the control stick forward or backward to highlight the desired cross hatch frequency. Use the left and right arrow to scroll to another page. Press **ENTER**, if the desired block is selected.

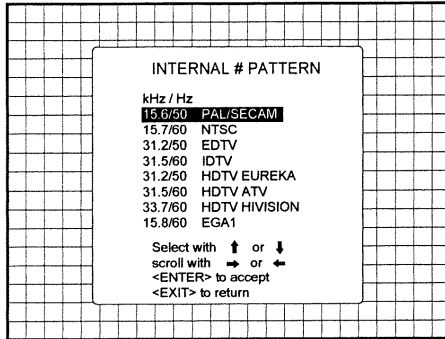

ENTER continues to the Random Access Adjustment Mode.
EXIT returns to the Setup Pattern Selection menu.

kHz/Hz

15.6/50	PAL/SECAM
15.7/60	NTSC
31.2/50	EDTV
31.5/60	IDTV
31.2/50	HDTV EUREKA
31.5/60	HDTV ATV
33.7/60	HDTV HISION
15.8/60	EGA 1
21.8/60	EGA 2
31.5/70	VGA 1, 2
35.5/87	VGA 4
48.5/60	SUPER VGA 1
44.2/70	SUPER VGA 2
61.0/76	SUPER VGA 3
63.9/76	APOLLO
22.2/60	MAC CLASSIC

RANDOM ACCESS ADJUSTMENT MODE

Random access adjustment mode selection menu.

This is the main menu for the Random Access adjustment mode.

Through this menu, the following adjustments and features are accessible :

- Picture Tuning
 - Enhanced Blue (only for RGB)
 - Sync slow/fast(video/s-video)
 - Color Balance
- Focusing
- Geometry
- Convergence
- Color select

And also Orbiting, Contrast modulation and Soft Edge if these options are installed.

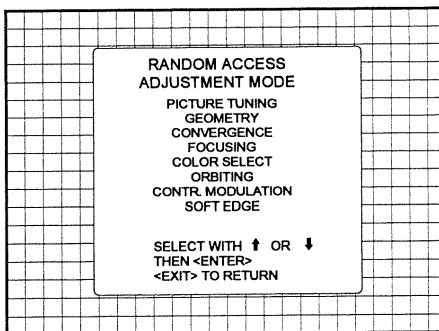

Picture Tuning

Highlight *Picture tuning* by pushing the control stick forward or backward and press **ENTER**.

The Picture tuning menu will be displayed.

Depending on the input source, the Picture tuning menu will display different items.

For Video or S-Video input sources :

- Color Balance
- Sync slow / fast

For RGB analog sources :

- Color Balance
- Enhanced Blue on /off

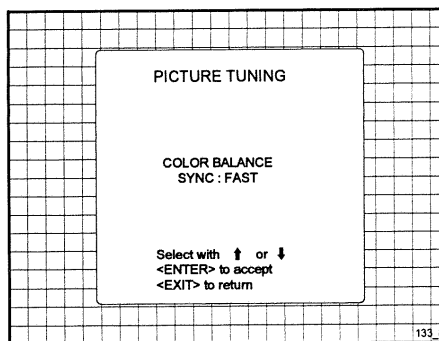

Color Balance

The Color Balance function is used to select or adjust the color temperature of white used by the projector.

The Color Balance can be adjusted on two different ways :

- fixed color balance. You have the choice between 3200 K (reddish), 4900 K, 6500 K (white) or 9300 K (bluish).
- Custom white and black balance.

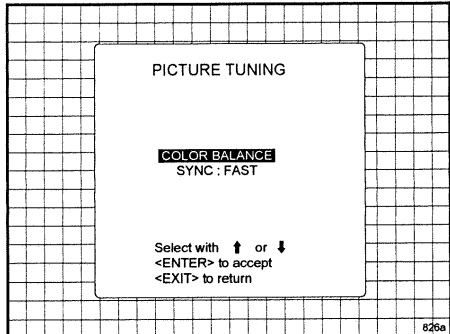

Fixed Color Balance.

Highlight one of the 4 preprogrammed color temperatures with the control stick and press **ENTER** to display the desired color balance.

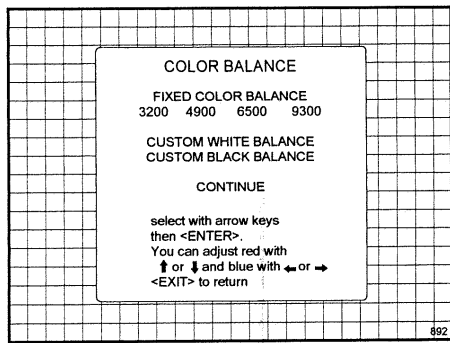

Custom Color Balance.

Select custom white balance with the joy stikc and press **ENTER** to start the adjustment. Push the control stick forward or backward to adjust the red gain and push the control stick to the left or to the right to adjust the blue gain. A bar scale indicates the amount of adjustment.

EXIT returns to the Picture tuning menu.

Select custom black balance with the control stick and press enter to start the adjustment. Push the control stick forward or backward to adjust the red cut-off and push the control stick to the left or to the right to adjust the blue cut-off.

When the color balance is adjusted, select continue with the control stick and press **ENTER**.

RANDOM ACCESS ADJUSTMENT MODE

Sync Fast/Slow Adjustment

The sync function is used to minimize horizontal jittering or tearing at the top to the displayed image.

Highlight **SYNC** by pushing the control stick forward or backward and press **ENTER** to toggle between **FAST** and **SLOW**.

Note: SYNC is normally used in the SLOW position. The FAST position is used to compensate for unsteady sync pulses from older video playback equipment.

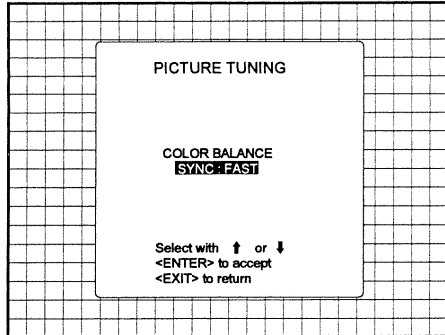

ENTER will toggle Sync between **FAST** and **SLOW**
EXIT will return to Setup Pattern Selection

Enhanced Blue On/Off Adjustment

Highlight **ENHANCED BLUE** by pushing the control stick forward or backward and press **ENTER** to toggle between **ON** and **OFF**. (only available when RGB signals are connected)
When 'Enhanced Blue' is **ON**, the blue color will be displayed as cyan.

Note: Enhanced blue is only used when an RGBS or RGsB analog signal from a computer is being displayed. Enhanced blue is not recommended for non-computer generated images.

For displaying graphics, this 'Enhanced Blue' function may falsify the color reproduction. In this case, put Enhanced Blue in the **OFF** position.

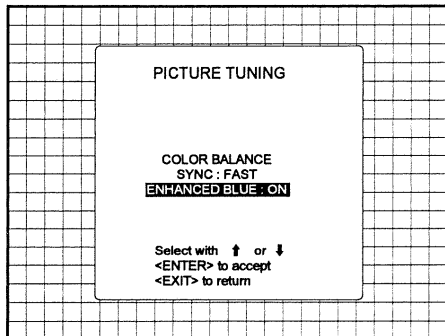

ENTER will toggle Enhanced Blue between **ON** and **OFF**
EXIT will return to the Random access main menu.
ADJUST returns to operational mode

Color Select

Highlight *COLOR SELECT* by pushing the control stick forward or backward and press **ENTER** to display the color select menu.

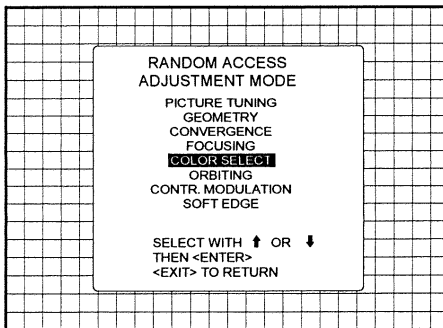

ENTER continues to the color select menu
EXIT will return to Internal Crosshatch Selection or Setup Pattern Selection menu
ADJUST returns to operational mode

Use the arrow keys to highlight a color (CRT) or combination of colors to display the projected image in that specific color.

To select a new color, press **ENTER**, the color selection menu appears again on the screen. To terminate the color select procedure, press **EXIT**.

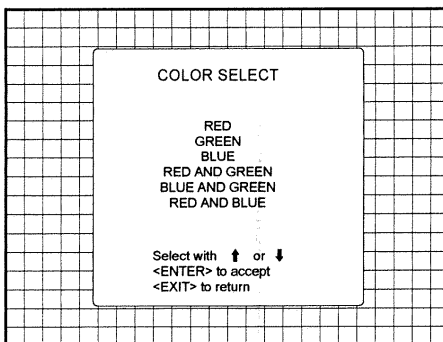

ENTER continues with the selected color or color combination.
EXIT returns to the Random access main menu.

RANDOM ACCESS ADJUSTMENT MODE

Focusing

Before starting the 'focusing' adjustment, be sure the lenses are correctly focused. Push the control stick forward or backward to select 'Focusing' and press **ENTER**.

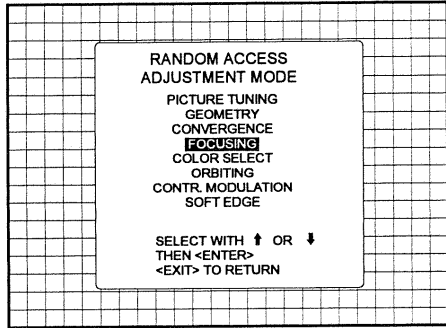

ENTER continues to the Focusing color select menu.
EXIT returns to Internal Crosshatch Selection or Setup Pattern Selection menu.
ADJUST returns to operational mode.

Focusing color select.

The focusing has to be done for the three colors separately. Therefore, start by selecting Green by pushing the control stick forward or backward and adjust Midpoint, top, bottom left and right focusing. Return to this focusing color select menu and continue with Red and Blue. Repeat for both colors Midpoint, top, bottom left and right focusing.

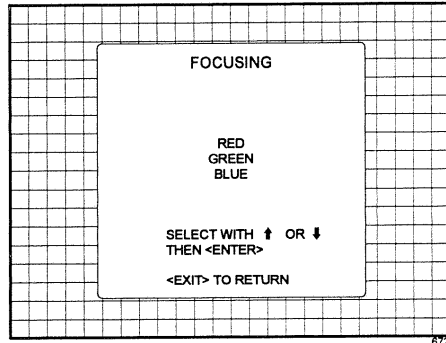

ENTER selects the focusing menu for the selected color.
EXIT returns to the Random access main menu.

Midpoint focusing

Push the control stick forward or backward to select midpoint and press **ENTER**.

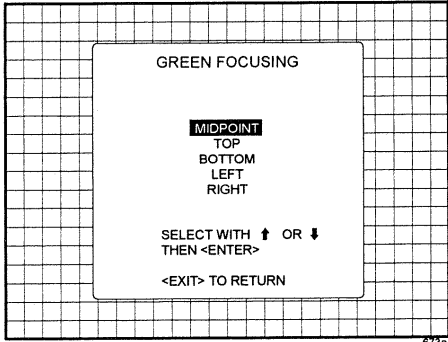

ENTER continues with the midpoint focusing for the selected color.
EXIT returns to the focusing color select menu.

Adjust by pushing the control stick to the left or to the right until the center of the image is sharp.

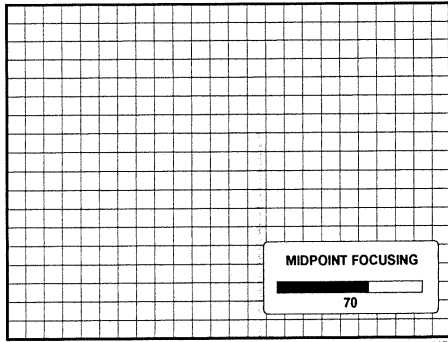

Press **ENTER** to return to the focusing menu.

RANDOM ACCESS ADJUSTMENT MODE

Top image focusing

The same procedure has to be repeated as for the midpoint focusing.

Push the control stick forward or backward and press **ENTER** to continue to the top focusing.

Push the control stick to the left or to the right to adjust the top focusing. Adjust until the upper part of the image is sharp.

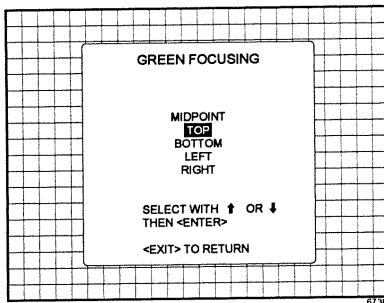

ENTER returns to the focusing menu.
EXIT returns to the focusing color select menu.

Bottom image focusing

The same procedure has to be repeated as for the midpoint focusing.

Push the control stick forward or backward to select bottom and press **ENTER** to continue to the bottom focusing.

Push the control stick forward or backward to adjust the bottom focusing. Adjust until the lower part of the image is sharp.

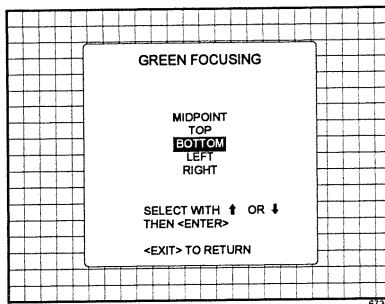

ENTER returns to the focusing menu.
EXIT returns to the focusing color select menu.

Left image focusing

The same procedure has to be repeated as for the midpoint focusing.

Push the control stick forward or backward to select LEFT and press **ENTER** to continue to the left focusing.

Push the control stick forward or backward to adjust the left focusing. Adjust until the left part of the image is sharp.

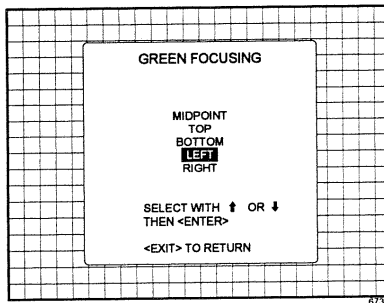

ENTER returns to the focusing menu.
EXIT returns to the focusing color select menu.

RANDOM ACCESS ADJUSTMENT MODE

Right image focusing

The same procedure has to be repeated as for the mid-point focusing.

Push the control stick forward or backward to select **RIGHT** and press **ENTER** to continue to the right focusing.

Push the control stick to the left or to the right to adjust the right focusing. Adjust until the right part of the image is sharp.

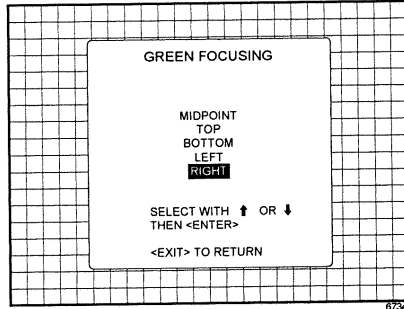

ENTER returns to the focusing menu.
EXIT returns to the focusing color select menu.

Geometry Adjustments

The geometry adjustments have to be done only on the green image. These adjustments are automatically implemented for the other color images: Left-right (EW) and Top-Bottom Corrections, Blanking, Horizontal Amplitude, Vertical Amplitude, Vertical Linearity and Horizontal Phase.

Highlight **GEOMETRY** by pushing the control stick forward or backward and press **ENTER** to display the geometry menu.

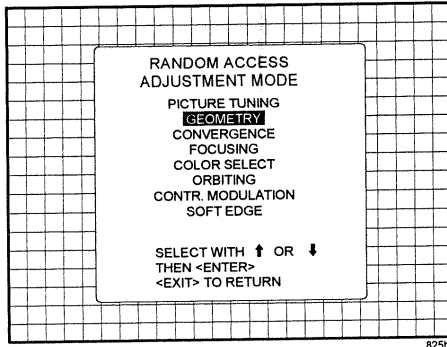

ENTER will display Geometry menu
EXIT will return to Internal Crosshatch Selection or Setup Pattern Selection Menu
ADJUST returns to operational mode

RANDOM ACCESS ADJUSTMENT MODE

Within the Geometry Adjustment menu, the following adjustments are available :

- Horizontal Phase (not for internal # pattern).
- Raster Shift
- Left-Right Corrections
- Left Side Corrections
- Top-Bottom Corrections
- Horizontal Size
- Vertical Linearity
- Vertical Size
- Blanking

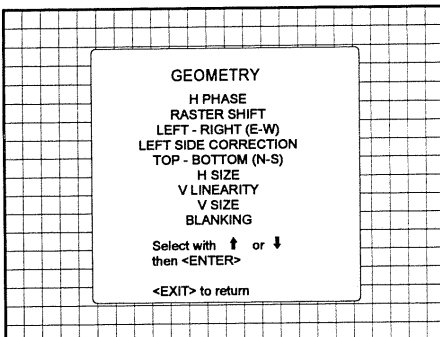

The convergence corrections are disabled during geometry corrections. The blanking corrections are only enabled during the blanking adjustments.

ENTER will display the selected option
EXIT will return to Random Access Adjustment Mode main menu
ADJUST returns to operational mode

Horizontal Phase Adjustment

Push the control stick forward or backward to highlight *H PHASE* on *Geometry menu* and then press **ENTER**.

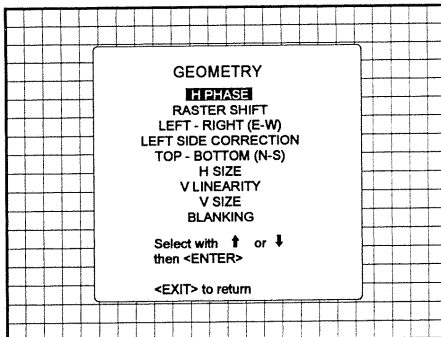

ENTER will select the horizontal phase adjustment.
EXIT returns to the Random access adjustment main menu.
ADJUST returns to operational mode.

RANDOM ACCESS ADJUSTMENT MODE

Note : No horizontal phase adjustment is available on the internal # pattern.

For external sources :
If the raster shift is correctly adjusted, the H Phase text box is projected in the middle of the raster. At that moment, the "><" icon indicates the middle of the raster.
Adjust the H Phase control until the middle of the projected image is equal with the middle of >< icon.

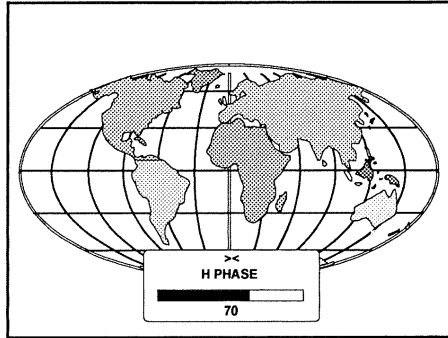

ENTER continues to geometry menu .

Note :
- if the genlocked pattern was selected, the external source will be displayed.

A bar scale and a number indicator (between 0 and 100) on the screen give a visual indication of the horizontal phase adjustment.

Correct by pushing the control stick to the right

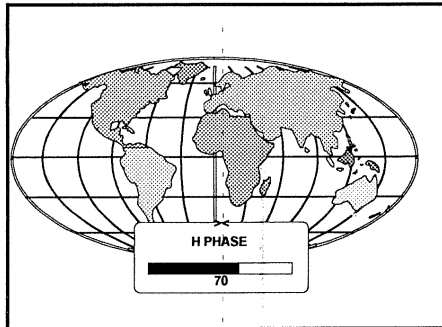

Correct by pushing the control stick to the left

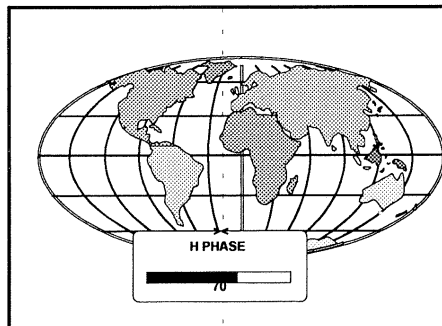

RANDOM ACCESS ADJUSTMENT MODE

Raster Shift Adjustment

The green raster must be centered both horizontally and vertically on the center of the CRT surface. To center the green raster, look into the green lens and use the control stick to move the raster.

CAUTION

It is necessary to look into the lenses to perform these adjustments. To avoid eye discomfort while looking into the lenses, reduce the contrast and gradually increase the brightness level until the raster becomes visible on the face of the CRT.

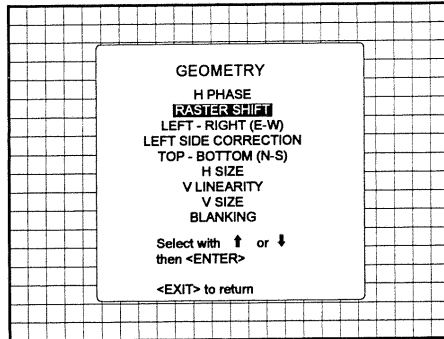

ENTER will select green raster shift adjustment
EXIT returns to random access adjustment mode menu.

Warning : In order to ensure maximum CRT longevity and to avoid CRT damage, do not shift the raster outside the phosphor area of the CRT.

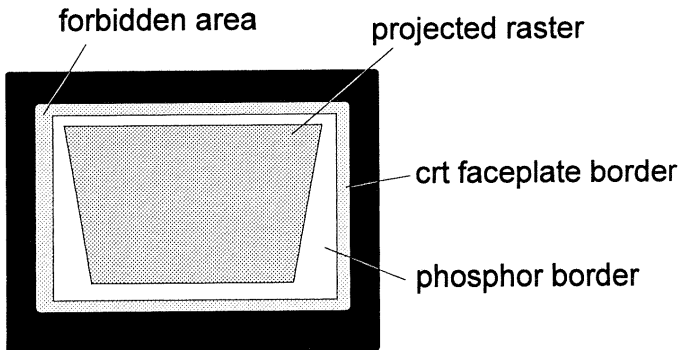

To start the adjustment, use the control stick to highlight Raster shift and press ENTER to display the green raster on the phosphor.

RANDOM ACCESS ADJUSTMENT MODE

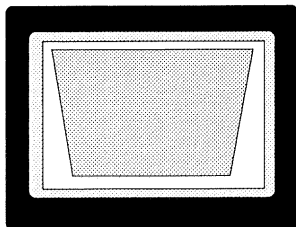

correct raster position

wrong raster positions

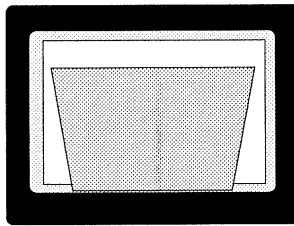
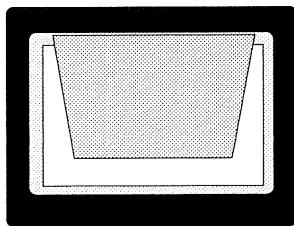
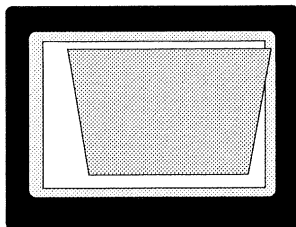
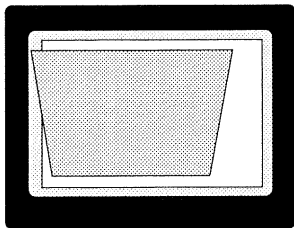

233

Press EXIT to return to the Geometry menu.

RANDOM ACCESS ADJUSTMENT MODE

Left-Right (east-west) Adjustments

Left-right adjustments affect only the vertical lines of the projected image. Only the green image is displayed while making left-right adjustments. The red and blue images will automatically be corrected in the same manner. Convergence corrections are automatically disabled for the duration of these adjustments.

The following adjustments can be executed

- Vertical Centerline Bow
- Vertical Centerline Skew
- Side Bow
- Side Keystone
- Seagull correction

Push the control stick forward or backward to highlight *LEFT-RIGHT (E/W)* on the geometry menu and then press **ENTER**.

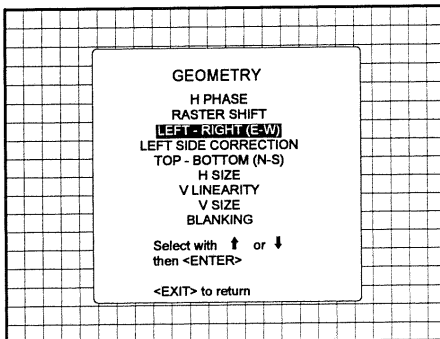

ENTER will select Left-Right adjustment menu
EXIT returns to random access adjustment mode main menu.
ADJUST returns to operational mode

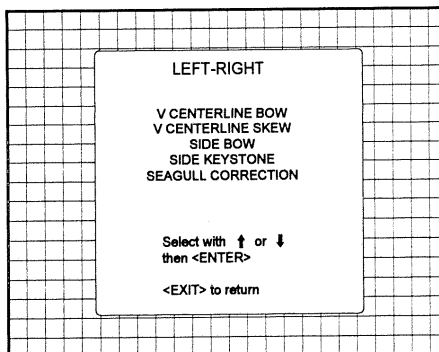

Vertical Centerline Bow Adjustment

The vertical centerline bow function corrects for curvature of the vertical lines in the horizontal direction in the middle of the picture.

Push the control stick forward or backward to highlight *V CENTERLINE BOW* on the Left-Right menu and then press **ENTER**.

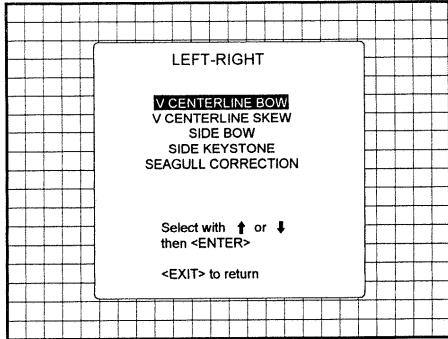

ENTER will select vertical centerline bow adjustment
EXIT will return to Geometry menu
ADJUST returns to operational mode

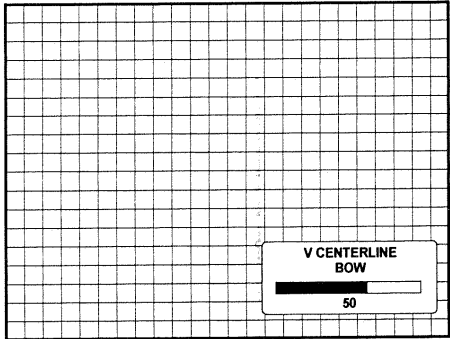

Vertical centerline

Correct by pushing the control stick to the right



Correct by pushing the control stick to the left



ENTER will return to Left-Right adjustment menu
EXIT will return to Geometry menu

RANDOM ACCESS ADJUSTMENT MODE

Vertical Centerline Skew Adjustment

The vertical centerline skew function corrects for tilting of the displayed image. Push the control stick forward or backward to highlight *V CENTERLINE SKEW* on the geometry menu and then press **ENTER**

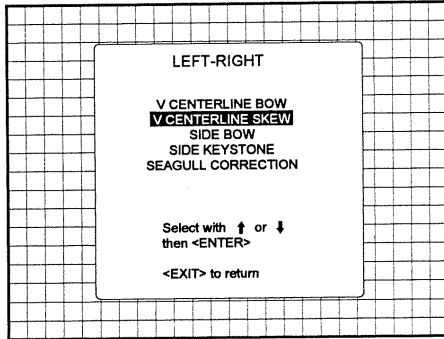

ENTER will select vertical centerline skew adjustment
EXIT will return to Geometry menu
ADJUST returns to operational mode

Adjust by pushing the control stick to the left or to the right until the vertical centerline is straight. Misalignment of the outer vertical lines will be corrected with the bow and keystone corrections. Press **ENTER** to continue.

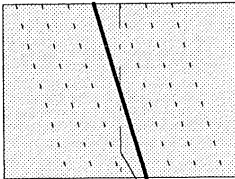
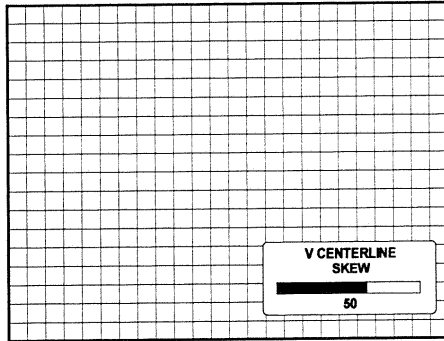

Correct by pushing the control stick to the right

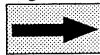

Vertical centerline

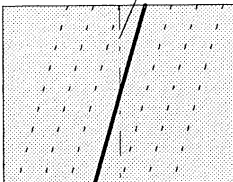

Correct by pushing the control stick to the left



ENTER will return to Left-Right adjustment menu
EXIT will return to Geometry menu

Side Bow Adjustment

The side bow adjustment corrects for curvature occurring at the sides of the displayed image and that for the vertical lines. Look only to the right side of the image while adjusting this control.

Push the control stick forward or backward to highlight **SIDE BOW** on the Geometry menu and then press **ENTER**.

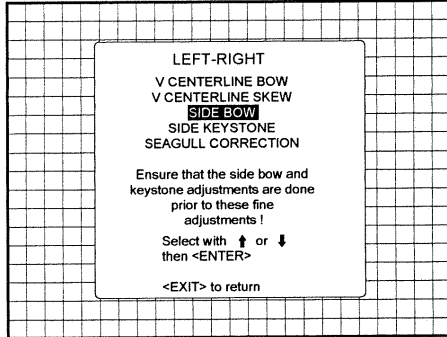

ENTER will select side bow adjustment
EXIT will return to Geometry menu
ADJUST returns to operational mode

Push the control stick to the left or to the right to adjust the side bow of the setup pattern (vertical lines) and press **ENTER** to continue.

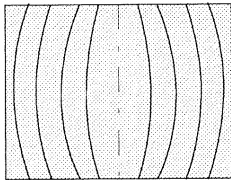
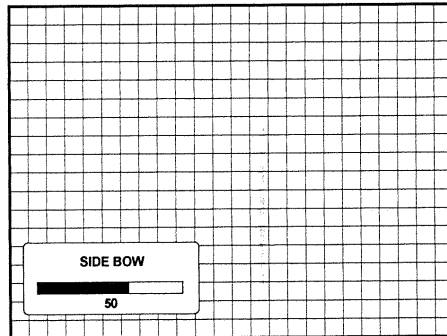

Correct by pushing the control stick to the right

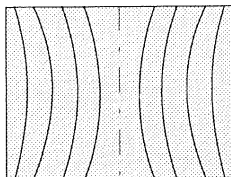

Correct by pushing the control stick to the left



ENTER will return to Left-Right adjustment menu
EXIT will return to Geometry menu

RANDOM ACCESS ADJUSTMENT MODE

Side Keystone Adjustment

The side keystone adjustment corrects the keystone geometry distortion of the vertical lines on the sides of the image. Look only to the right side of the image while adjusting this control.

Push the control stick forward or backward to highlight **SIDE KEYSTONE** on Left-Right menu and then press **ENTER**.

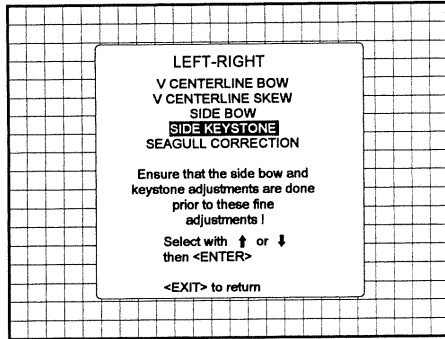

ENTER will select side keystone adjustment
EXIT will return to Geometry menu.
ADJUST returns to operational mode

Push the control stick to the left or to the right to adjust the side keystone (vertical lines) of the setup pattern and press **ENTER** to continue.

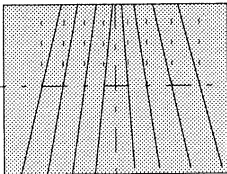
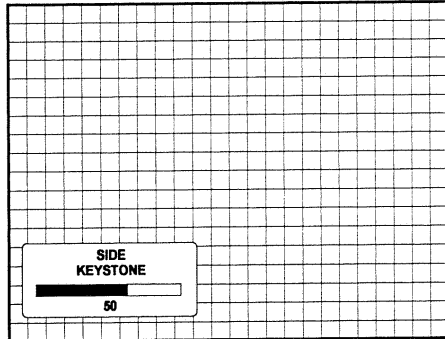

Correct by pushing the control stick to the right

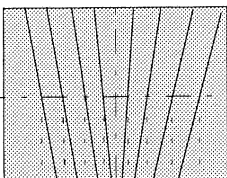
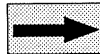

Correct by pushing the control stick to the left



ENTER will return to Left-Right adjustment menu
EXIT will return to Geometry menu

Seagull correction

Use this correction only if, after adjusting the vertical lines with the side bow or side keystone, still a 'S' deformation is visible on the left and the right side of the image. The default value on the bar scale for this correction is 50. Push the control stick forward or backward to highlight *SEAGULL CORRECTION* on the Left-Right menu and then press **ENTER**.

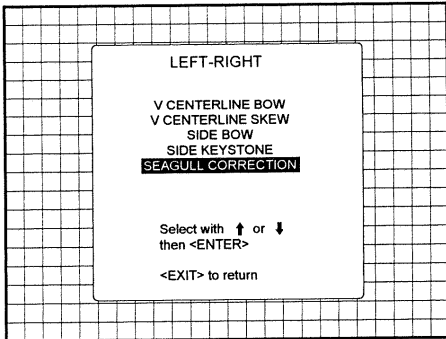

ENTER select the Seagull Correction.
EXIT returns to the Geometry menu.
ADJUST returns to operational mode.

Eliminate the deformation by pushing the control stick to the left or to the right until a straight line is obtained.

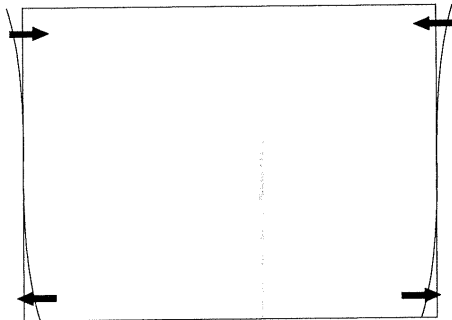

RANDOM ACCESS ADJUSTMENT MODE

Left Side Correction

Left side corrections affect only the vertical lines of the set up pattern. Only the green image is displayed while making the left side adjustments. The red and blue images will automatically be corrected in the same manner.

Convergence corrections are automatically disabled for the duration of these adjustments.

Look only to the left side of the image while adjusting these fine tunings (bow and keystone). Before starting the left side correction, insure that the side bow and keystone adjustments are done prior to these fine adjustments !

The following adjustments can be executed :

- Left keystone
- Left bow

Push the control stick forward or backward to highlight **LEFT SIDE CORRECTION** on the geometry menu and then press **ENTER**.

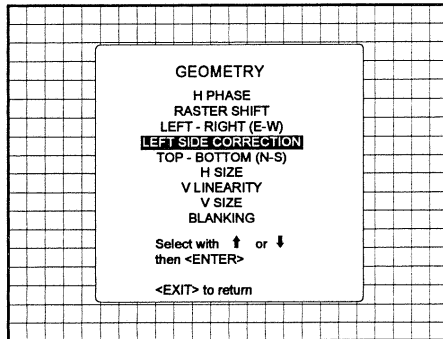

ENTER will select the Left Side Correction menu.

EXIT will return to the random access adjustment menu.

ADJUST returns to operational mode.

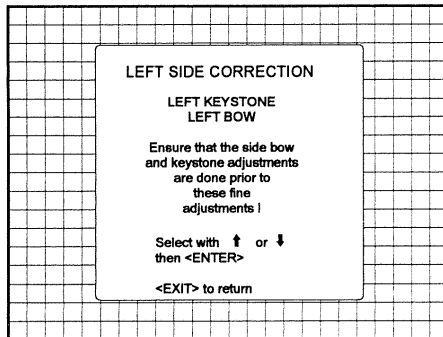

Left keystone

The left keystone adjustment corrects the keystone geometry distortion of the vertical lines on the left side of the image.

Push the control stick forward or backward to highlight **LEFT KEYSTONE** on Left-Right menu and then press **ENTER**.

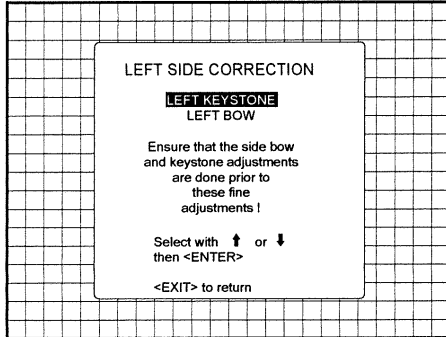

ENTER will select Left Keystone adjustment
EXIT will return to Geometry menu.
ADJUST returns to operational mode

Push the control stick to the left or to the right to adjust the left keystone (vertical lines) of the setup pattern and press **ENTER** to continue.

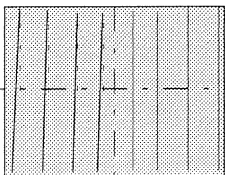
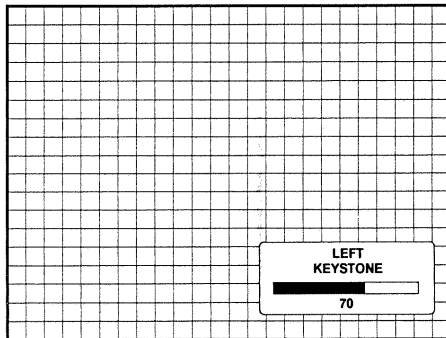

Correct by pushing the control stick to the right

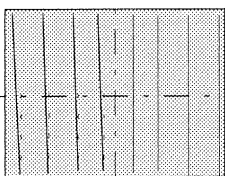

Correct by pushing the control stick to the left

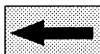

ENTER will return to the Left Side Correction menu.
EXIT will return to the Geometry menu.

RANDOM ACCESS ADJUSTMENT MODE

Left bow

The left bow adjustment corrects for curvatura occurring at the left side of the image and that for the vertical lines.

Push the control stick forward or backward to highlight **LEFT BOW** on Left-Right menu and then press **ENTER**.

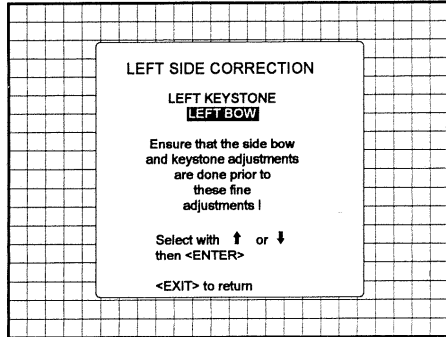

ENTER will select Left Bow adjustment
EXIT will return to Geometry menu.
ADJUST returns to operational mode

Push the control stick to the left or to the right to adjust the left bow (vertical lines) of the setup pattern and press **ENTER** to continue.

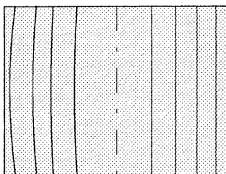
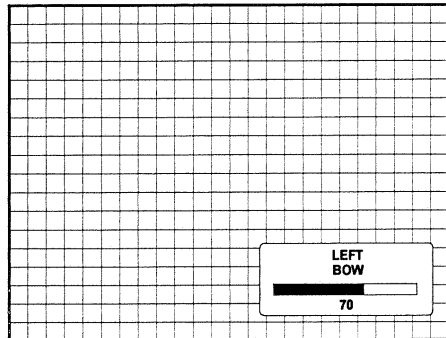

Correct by pushing the control stick to the right

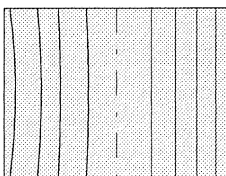

Correct by pushing the control stick to the left



ENTER will return to the Left Side Correction menu.
EXIT will return to the Geometry menu.

Top-Bottom (north-south) Adjustments

Top-Bottom adjustments affect only the horizontal lines of the projected image. Convergence corrections are automatically disabled for the duration of these adjustments.

Push the control stick forward or backward to highlight *TOP-BOTTOM (N/S)* on the geometry menu and then press **ENTER**.

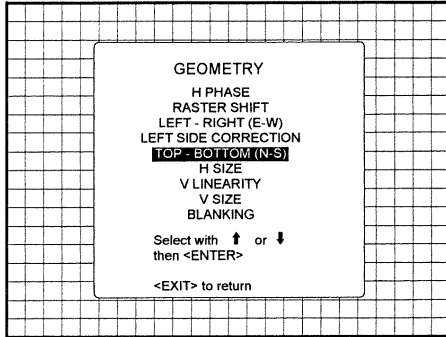

ENTER will select Top-Bottom adjustment menu
EXIT returns to random access adjustment mode menu.
ADJUST returns to operational mode

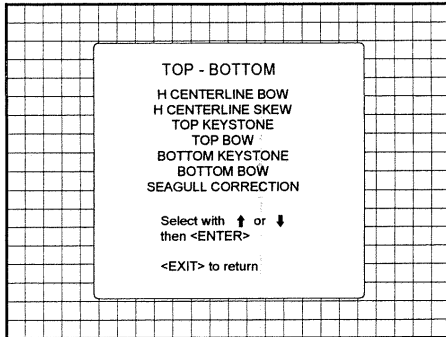

EXIT will return to Geometry

RANDOM ACCESS ADJUSTMENT MODE

Horizontal Centerline Bow Adjustment

The horizontal centerline bow function corrects for curvature in the vertical direction in the middle of the image and that for the horizontal lines.

Push the control stick forward or backward to highlight **H CENTERLINE BOW** on the TOP-BOTTOM menu and then press **ENTER**.

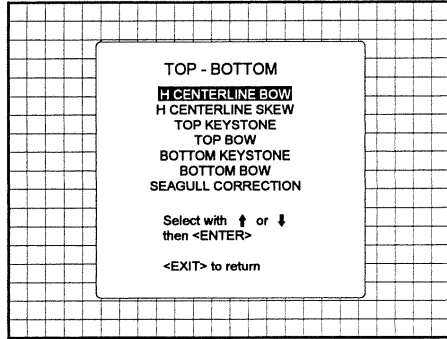

ENTER will select horizontal centerline bow adjustment
EXIT will return to Geometry menu
ADJUST returns to operational mode

Push the control stick forward or backward to adjust the horizontal centerline bow of the setup pattern.

A bar scale and a number indicator will give a visual indication of the bow correction.

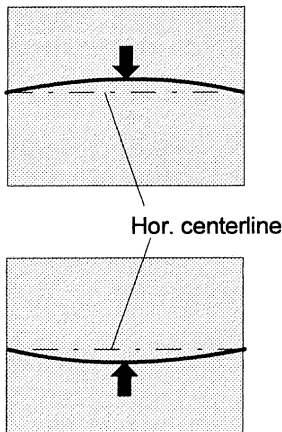
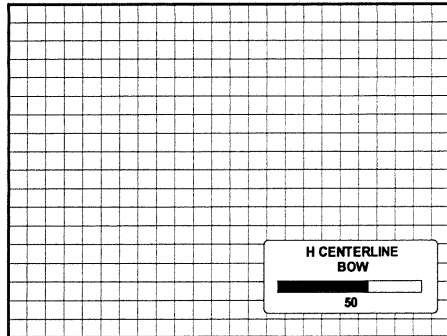

Correct by pushing the control stick backward

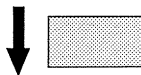

Correct by pushing the control stick forward

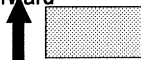

ENTER will return to Top-Bottom adjustment menu
EXIT will return to Geometry menu

Horizontal Centerline Skew Adjustment

The horizontal centerline skew function corrects for tilting of the horizontal lines in the middle of the image.

Push the control stick forward or backward to highlight *H CENTERLINE SKEW* on the TOP-BOTTOM menu and then press **ENTER**.

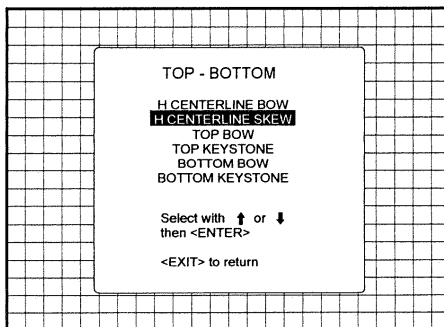

403b

ENTER will select horizontal centerline skew adjustment
EXIT will return to Geometry menu
ADJUST returns to operational mode

Push the control stick forward or backward to adjust the horizontal centerline skew of the setup pattern.

A bar scale and a number indicator will give a visual indication of the skew correction.

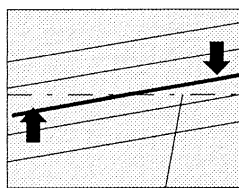
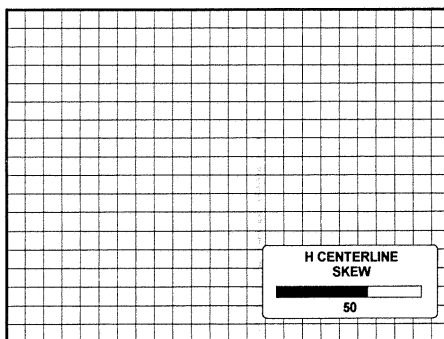

Hor. centerline

Correct by pushing the control stick backward

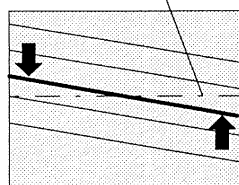
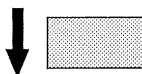

Correct by pushing the control stick forward

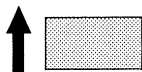

ENTER will return to Top-Bottom adjustment menu
EXIT will return to Geometry menu

RANDOM ACCESS ADJUSTMENT MODE

Top Bow Adjustment

The top bow function corrects for curvature occurring in the upper part of the image.
Push the control stick forward or backward to highlight **TOP BOW** on the TOP-BOTTOM menu and then press **ENTER**.

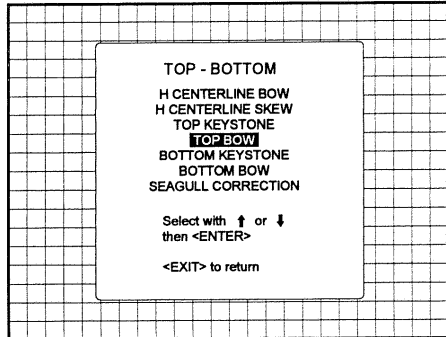

ENTER will select top bow adjustment
EXIT will return to Geometry menu
ADJUST returns to operational mode

Adjust the bow of the horizontal lines in the upper side of the image by pushing the control stick forward or backward until these lines are straight.

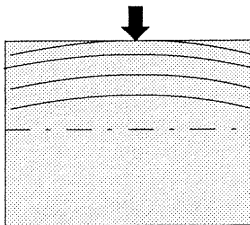
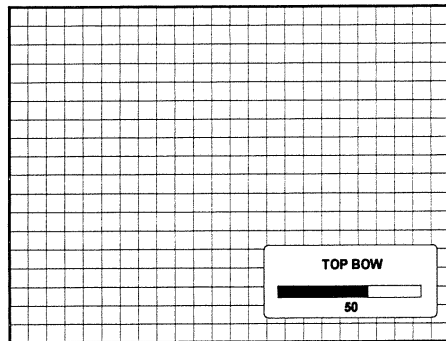

Correct by pushing the control stick backward

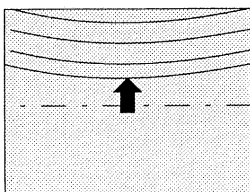
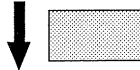

Correct by pushing the control stick forward

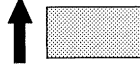

ENTER will return to Top-Bottom adjustment menu
EXIT will return to Geometry menu

Top Keystone Adjustment

The top keystone function corrects for keystone geometry distortion of the horizontal lines in the upper part of the image. Push the control stick forward or backward to highlight **TOP KEYSTONE** on the TOP-BOTTOM menu and then press **ENTER**.

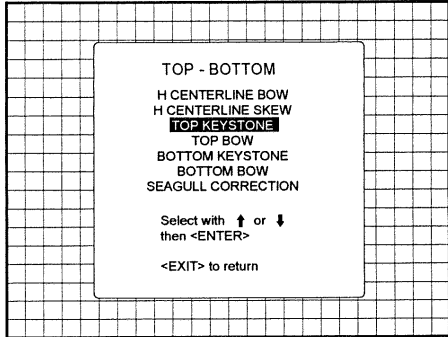

ENTER will select top keystone adjustment
EXIT will return to Geometry menu
ADJUST returns to operational mode

Adjust the horizontal lines in the upper part of the picture by pushing the control stick forward or backward until these lines straight. Press **ENTER** to continue.

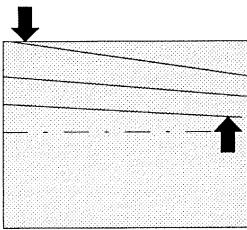
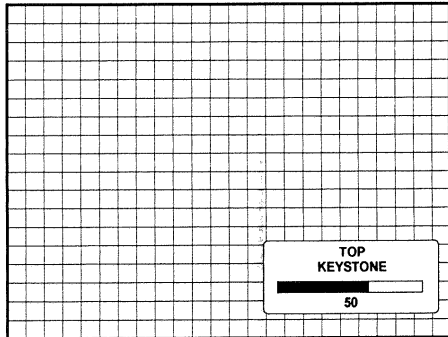

Correct by pushing the control stick backward

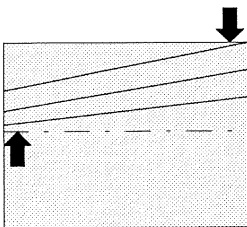

Correct by pushing the control stick forward

ENTER will return to Top-Bottom adjustment menu
EXIT will return to Geometry menu

RANDOM ACCESS ADJUSTMENT MODE

Bottom Bow Adjustment

The bottom bow function corrects for curvature occurring in the lower part of the image. Push the control stick forward or backward to highlight **BOTTOM BOW** on the TOP-BOTTOM menu and then press **ENTER**.

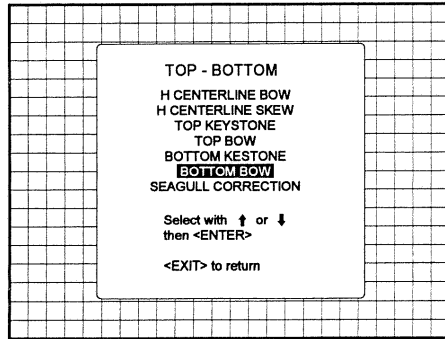

ENTER will select bottom bow adjustment
EXIT will return to Geometry menu
ADJUST returns to operational mode

Push the control stick forward or backward to adjust the bottom bow in the lower part of the setup pattern. Adjust until the horizontal lines are straight.

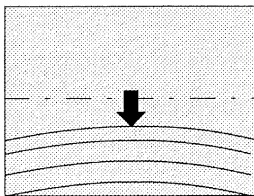
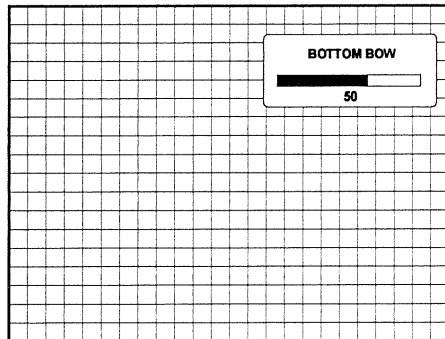

Correct by pushing the control stick backward

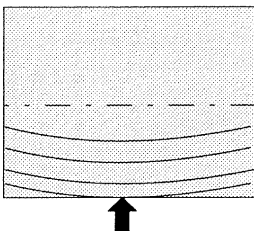

Correct by pushing the control stick forward



ENTER will return to Top-Bottom adjustment menu
EXIT will return to Geometry menu

Bottom Keystone Adjustment

The bottom keystone function corrects for keystone geometry distortion of the horizontal lines in the middle of the image. Push the control stick forward or backward to highlight **BOTTOM KEYSTONE** on the TOP-BOTTOM menu and then press **ENTER**.

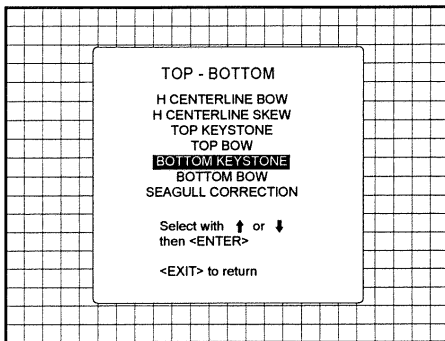

ENTER will select bottom keystone adjustment
EXIT will return to Geometry menu
ADJUST returns to operational mode

Adjust the horizontal lines in the lower part of the image by pushing the control stick forward or backward until these lines are straight.

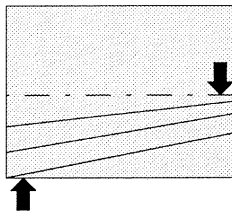
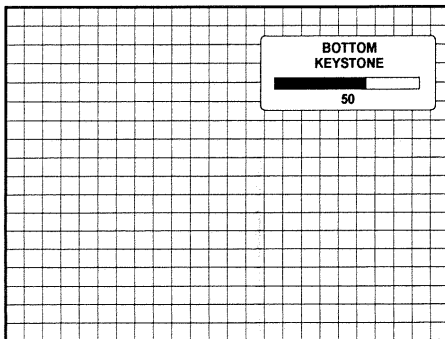

Correct by pushing the control stick backward

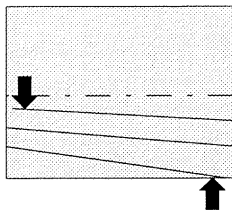

Correct by pushing the control stick forward

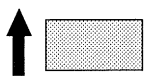

ENTER will return to Top-Bottom adjustment menu
EXIT will return to Geometry menu

RANDOM ACCESS ADJUSTMENT MODE

Seagull Correction

Use this correction after the image has been adjusted with top and bottom bow and keystone. If still a deformation (like a seagull) on top and bottom of the image is visible, proceed to the seagull correction. Due to interaction, it is possible that the Top and Bottom Bow have to be readjusted after adjusting the seagull correction to obtain an improved image. The default value on the bar scale for this correction is 50. Push the control stick forward or backward to select the 'Seagull Correction' and press ENTER to select.

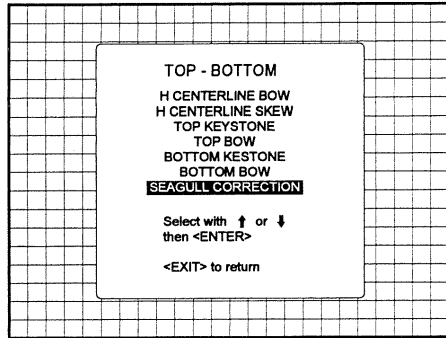

ENTER selects the Seagull Correction.
EXIT returns to the geometry menu.
ADJUST returns to operational mode.

Eliminate the deformation by pushing the control stick upwards or downwards until a straight line is obtained.

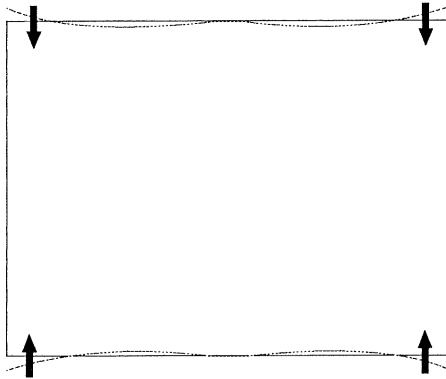

Horizontal Size Adjustment

Push the control stick forward or backward to highlight *H SIZE* on the Geometry menu and then press **ENTER**.

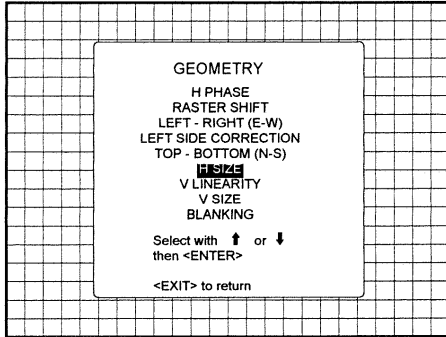

ENTER will select horizontal size adjustment
EXIT returns to random access adjustment mode menu.
ADJUST returns to operational mode

Adjust the horizontal size by the control stick to the right or to the left until the exact image width is obtained.

Note :

- if the internal # pattern was selected, this pattern remains on the screen.
- if the genlocked pattern was

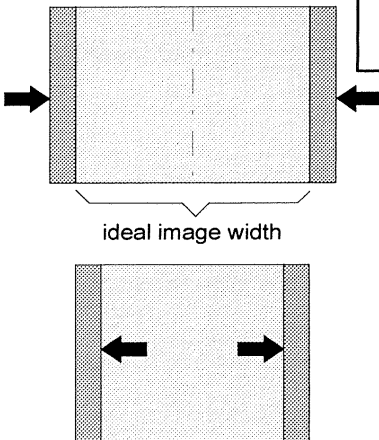
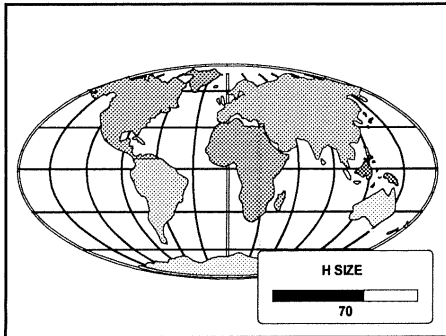

selected, the external source will be displayed.
 A bar scale and a numeric indicator help to gauge the horizontal size adjustment.

Hint : In order to avoid loss of resolution in the projected image and to ensure maximum CRT longevity, do not use an excessively small horizontal size setting.

EXIT will return to Geometry

Vertical Linearity Adjustment

The vertical linearity adjustment function corrects for vertical non-linearities which extend from the center of the image to the top and bottom of the image.

Push the control stick forward or backward to highlight **VLIN-*E*ARITY** on the Geometry menu and then press **ENTER**.

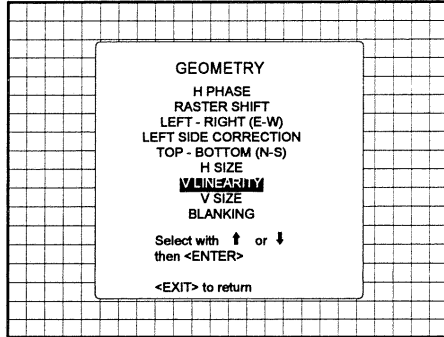

ENTER will select vertical linearity adjustment,
EXIT returns to random access adjustment mode menu,
ADJUST returns to operational mode

Adjust the vertical linearity with the control stick until the distances between the horizontal lines of the set up pattern are equal from top to bottom.

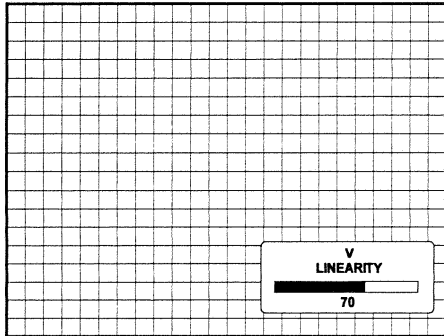

EXIT will return to the Geometry menu

Vertical Size Adjustment

Push the control stick forward or backward to highlight **V SIZE** on the Geometry menu and then press **ENTER**.

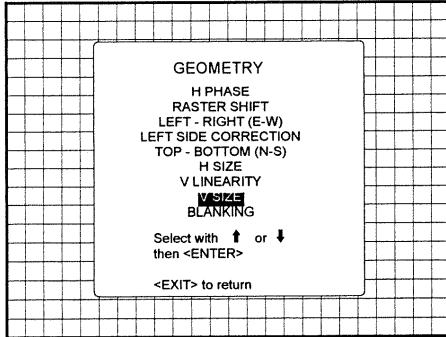

ENTER will select vertical size adjustment
EXIT returns to random access adjustment mode menu,
ADJUST returns to operational mode

Adjust the vertical size by pushing the control stick forward or backward until the correct image height is obtained.

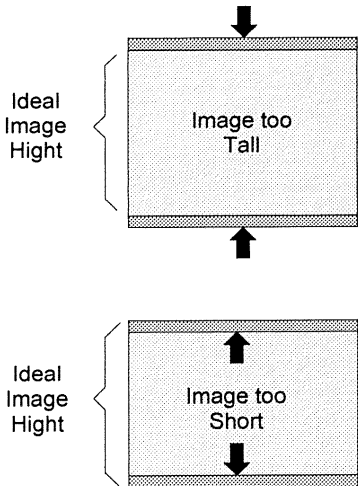
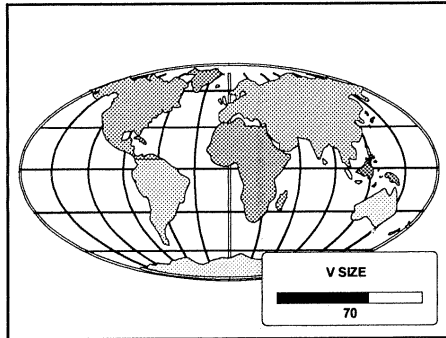

Note :

- if the internal # pattern was selected, this pattern remains on the screen.
- if the genlocked pattern was selected, the external source will be displayed.

A bar scale and a numeric indicator give a visual indication of the vertical size adjustment.

Hint : In order to avoid loss of resolution in the projected image and to ensure maximum CRT longevity, do not use an excessively small vertical size setting.

EXIT will return to Geometry

Blanking Adjustments

Push the control stick forward or backward to highlight **BLANKING** on the Geometry menu and then press **ENTER**.

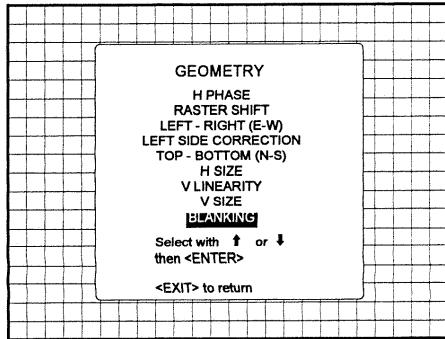

ENTER will select Blanking Adjustment menu
EXIT returns to Random Access Adjustment mode menu.
ADJUST returns to Operational mode

Blanking adjustments affect only the edges of the projected image and are used to frame the projected image on to the screen and to hide or black out unwanted information (or noise). A 0% on the bar scale indicates no blanking. The following blanking corrections are possible :

- top blanking
- bottom blanking
- left blanking
- right blanking

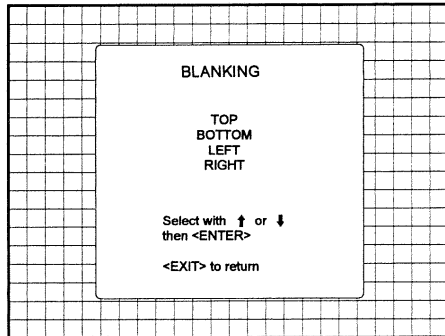

EXIT will return to Geometry
ADJUST returns to operational mode

Therefore :

- if the internal # pattern was selected, this pattern remains on the screen.
- if the genlocked pattern was selected, the external source will be displayed.

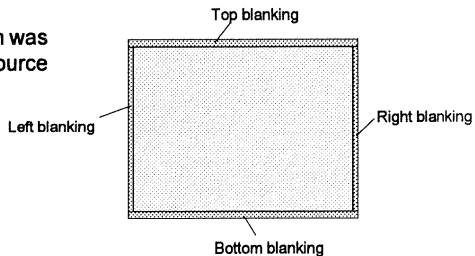

Top Blanking Adjustment

Push the control stick forward or backward to highlight **TOP** on the Blanking menu and then press **ENTER**.

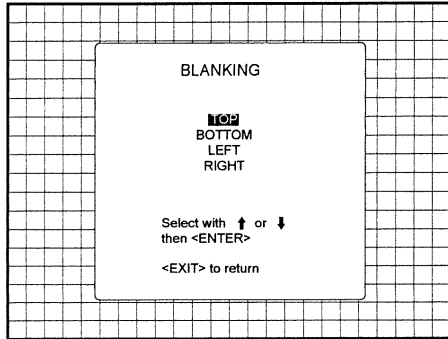

ENTER will select top blanking adjustment
EXIT will return to Geometry menu
ADJUST returns to operational mode

Push the control stick forward or backward to adjust the top blanking. Press **ENTER** to continue

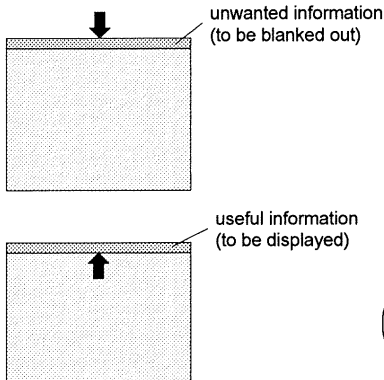
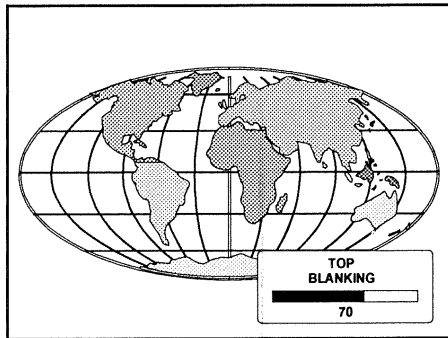

ENTER returns to the Blanking menu
EXIT returns to the Geometry menu

RANDOM ACCESS ADJUSTMENT MODE

RANDOM ACCESS ADJUSTMENT MODE

Bottom Blanking Adjustment

Push the control stick forward or backward to highlight **BOTTOM** on the Blanking menu and then press **ENTER**.

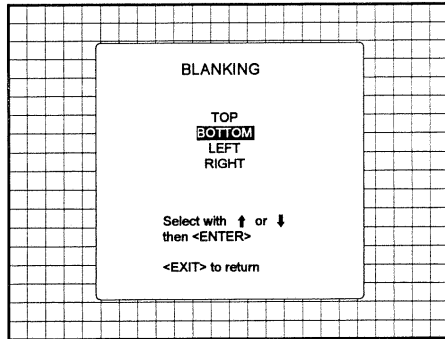

ENTER will select bottom blanking adjustment
EXIT will return to Geometry menu
ADJUST returns to operational mode

Push the control stick forward or backward to adjust the bottom blanking. Press **ENTER** to continue

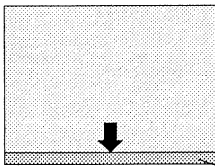
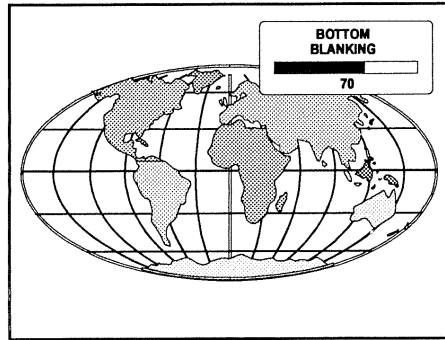

useful information
(to be displayed)

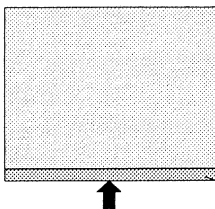

unwanted information
(to be blanked out)

ENTER returns to the Blanking menu
EXIT returns to the Geometry menu

RANDOM ACCESS ADJUSTMENT MODE

Left Blanking Adjustment

Push the control stick forward or backward to highlight *LEFT* on the Blanking menu and then press **ENTER**.

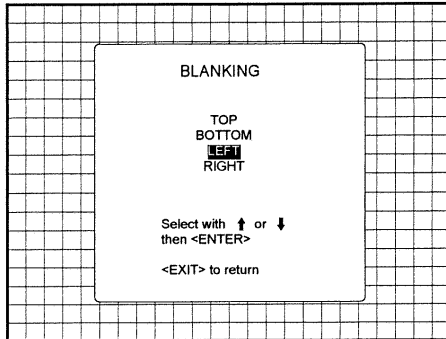

ENTER will select left blanking adjustment
EXIT will return to Geometry menu
ADJUST returns to operational mode

Push the control stick to the right or to the left to adjust the left blanking. Press **ENTER** to continue

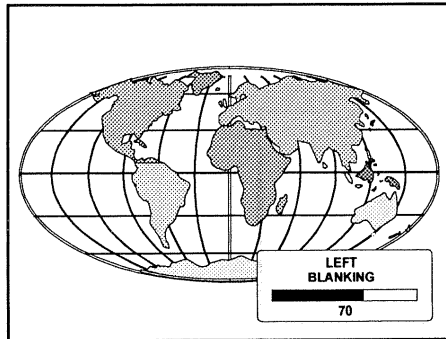

unwanted information
 (to be blanked out)

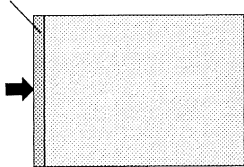

useful information
 (to be displayed)

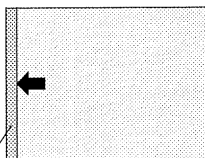

ENTER returns to the Blanking menu.
EXIT returns to the Geometry menu

RANDOM ACCESS ADJUSTMENT MODE

Right Blanking Adjustment

Push the control stick forward or backward to highlight **RIGHT** on the Blanking menu and then press **ENTER**.

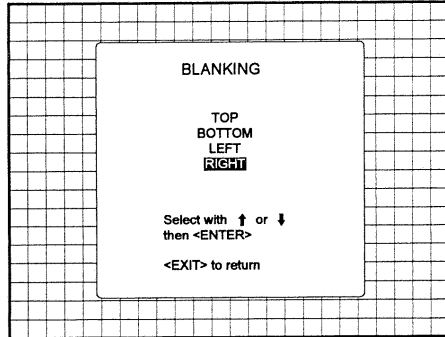

ENTER will select right blanking adjustment
EXIT will return to Geometry menu
ADJUST returns to operational mode

Push the control stick to the left or to the right to adjust the right blanking. Press **ENTER** to continue

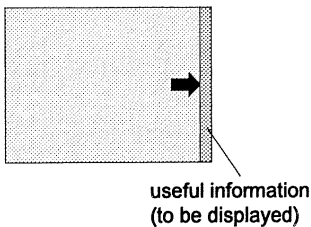
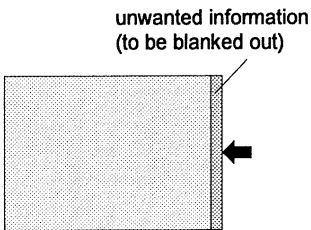
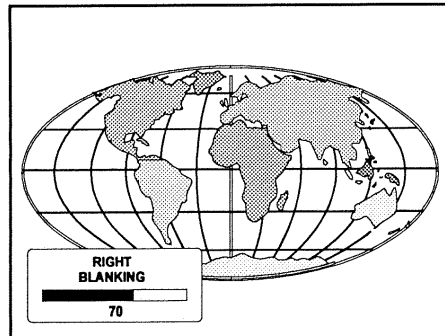

ENTER returns to the Blanking menu
EXIT returns to the Blanking menu

Convergence Adjustment

Convergence adjustments affect both the horizontal and vertical lines of the setup pattern. These adjustments are performed on the red image while superimposed on the green image and then on the blue image while superimposed on the green image.

Note : the green convergence adjustments can be added as an option. When these are available, always start with 'green only'. This option will also be indicated on the convergence menu.

Highlight first 'Green only' when available with the control stick and press **ENTER** to display the convergence adjustment menu

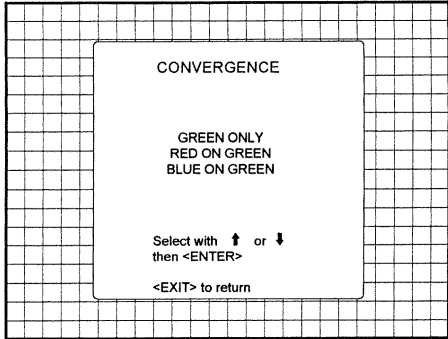

ENTER will display the Convergence menu.
EXIT will return to Random Access Adjustment Mode main menu.
ADJUST returns to operational mode.

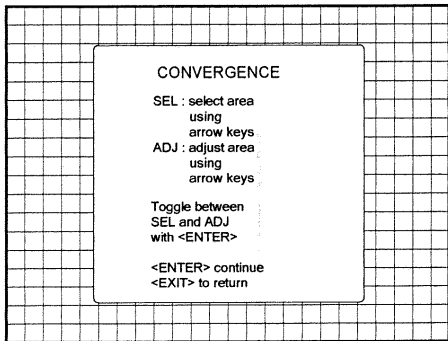

ENTER will continue to convergence adjustment
EXIT returns to convergence menu.

RANDOM ACCESS ADJUSTMENT MODE

The screen area is divided into 25 areas. Use the control stick to move the box to the desired zone and then press **ENTER** to begin the convergence adjustment. Start the convergence adjustment with zone one and continue as mentioned in the diagram hereafter.

Use the control stick to make horizontal or vertical convergence adjustments in the selected zone and then press **ENTER** to move the box to another zone or **EXIT** to return to the Convergence menu. **ENTER** toggles arrow keys between zone selection and zone adjustment.

25	23	9	15	17
24	22	8	14	16
5	4	1	2	3
20	18	6	10	12
21	19	7	11	13

397

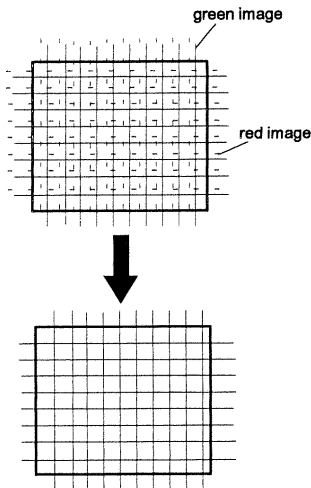
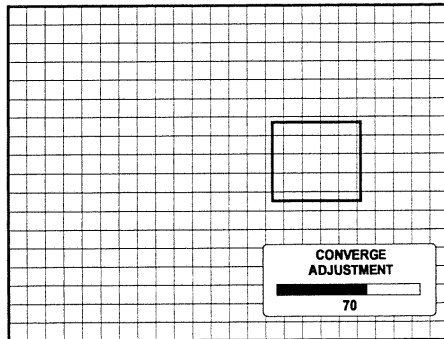

EXIT returns to convergence menu

RANDOM ACCESS ADJUSTMENT MODE

SERVICE MODE

Starting up the Service mode

Overview flow chart Service mode

Initialization

Copy a Block

Deletion of Blocks

Change Password

Change Language

Run Time

Set to Midposition

Convergence Mid

CRT Run in Cycle

Dynamic Astigmatism

G2 Adjustment

Projector Warm Up

Starting Up the Service mode.

Push the control stick forward or backward to highlight 'Service' and then press **ENTER**.

Some items in the Service mode are password protected (when the password function is active). Enter your password to continue. All other password protected items are now also free available if you stay in the adjustment mode.

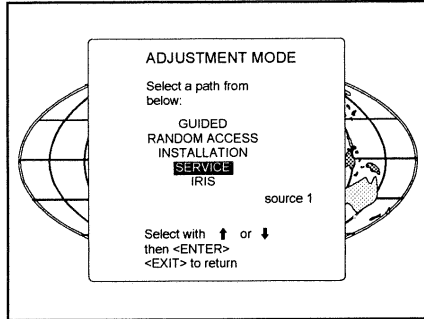

ENTER continues to service mode main menu.
EXIT returns to operational mode.

The service items are combined in two service menus. To switch from the first to the second menu or vice versa, push the control stick forward or backward to select 'more ...'.

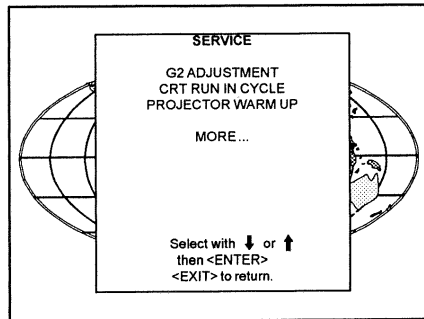
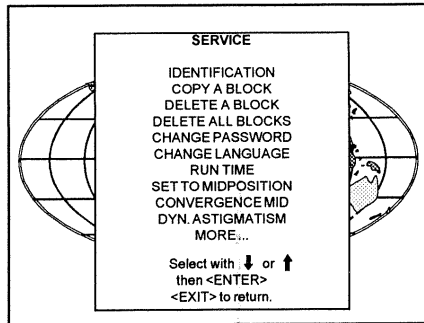

SERVICE MODE

Overview flowchart 'Service' mode.

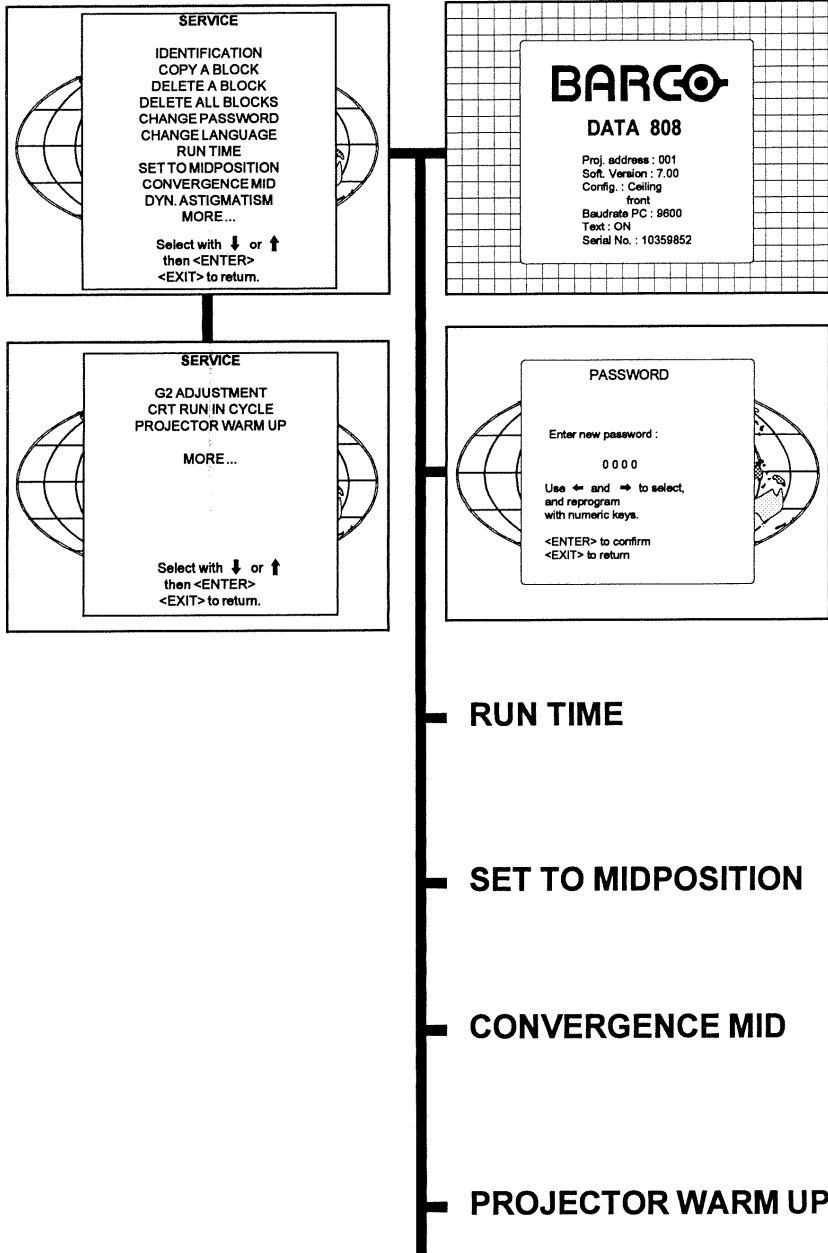

CRT RUN IN CYCLE

A flashing white pattern will be generated until <EXIT> is pressed.

The projector only uses memory blocks adjusted on an internal # pattern; if no such block is available, the projector can't run the procedure and leaves the adjustment mode.

<ENTER> to continue
<EXIT> to cancel

787

**SAFETY
NOTICE****RISK OF ELECTRICAL SHOCK**

G2 ADJUSTMENT SHOULD BE PERFORMED BY BARCO PERSONNEL OR BARCO AUTHORIZED DEALERS

IF QUALIFIED, PRESS <ENTER> TO CONTINUE OR IF NOT, <EXIT> TO RETURN.

DYNAMIC ASTIGMATISM

First adjust the defocusing of the image.

SEL : select area using arrow keys

ADJ : adjust axial astigmatism using

→ or ←, diagonal astigmatism using

↓ or ↑

Toggle between SEL and

ADJ with <ENTER>

<ENTER> to continue

<EXIT> to return

COPY MODE

Nr.	Src	Ph	Fv	inp	conf.
1	-	15.6	50	video	FC
2	3	31.2	80	RGB3S	RT
3	-	15.6	50	intern	FC
4	2	31.5	50	RGB3S	FC
5	-	33.7	80	intern	FC
6					
7					
8					

Active block nr. 1

Scroll with ↑ or ↓
 <ENTER> to copy
 <EXIT> to return

DELETE MODE

Nr.	Src	Ph	Fv	inp	conf.
1	-	15.6	50	video	FC
2	3	31.2	80	RGB3S	RT
3	-	15.6	50	intern	FC
4	2	31.5	50	RGB3S	FC
5	-	33.7	80	intern	FC
6					
7					
8					

Active block nr. 1

Scroll with ↑ or ↓
 <ENTER> to copy
 <EXIT> to return

DELETE ALL BLOCKS

!

All 32 blocks
will be deleted!

<ENTER> to confirm
 <EXIT> to cancel

LANGUAGE

ENGLISH
 ESPAÑOL
 FRANÇAIS
 DEUTSCH

Select new language
with ↑ or ↓
then <ENTER>
<EXIT> to return

Identification

Highlight '*Identification*' by pushing the control stick forward or backward and press **ENTER**.

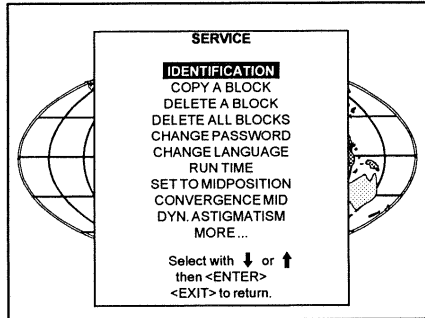

ENTER will start the selected item.
EXIT returns to the path selection main menu,

The '*Identification*' screen gives information concerning :

- projector address. To change the address of your projector, contact a qualified service technician.
- software version.
- configuration.
 - possible installations :
 - * front-ceiling
 - * front-table
 - * rear-ceiling
 - * rear-table



- baud rate PC : transfer speed for communication with a IBM PC (or compatible) or MAC. The baud rate of the projector must be the same as the baud rate of the connected computer. When there is a difference, contact a qualified service technician to make the appropriate changes.

- Text ON/OFF
Indicates in operational mode if the bar scale and number indicator will be displayed and if warnings and failures will be displayed.
ON : displayed
OFF : not displayed

The status can be changed by pressing the '*TEXT*' key once on the RCU.

SERVICE MODE

- Serial no. : indicates the fabrication number of the projector. This number can be useful when calling for technical assistance.

Change password

This item is password protected. Highlight '*change password*' by pushing the control stick forward or backward and press **ENTER**.

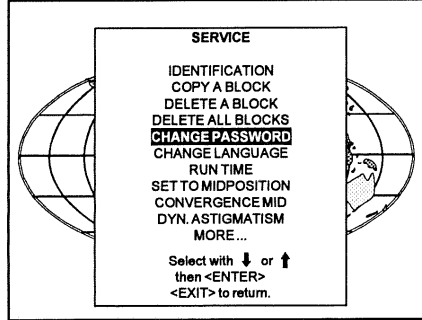

ENTER will display the selected item.
EXIT will returns to the path selection main menu.
ADJUST will returns to operational mode.

The current password is displayed. The new password must consist of 4 digits between 0 and 9. Push the control stick to the left or to the right to select the digits to be changed. Use the numeric keys to enter the new digits.

Press **ENTER** to save the new password. Before saving the new password, a confirmation screen will be displayed.

Press **EXIT** to return to the Service menu without saving the new password.

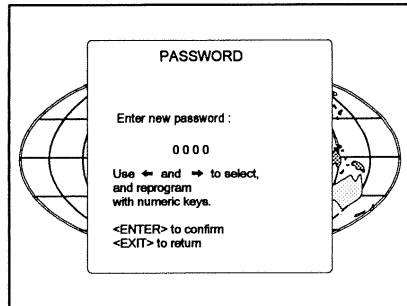

ENTER displays the confirmation menu.
EXIT returns to service mode without saving the new password.

When the displayed password is correct, press **ENTER** to save.
If not correct, press **EXIT** to cancel the saving.

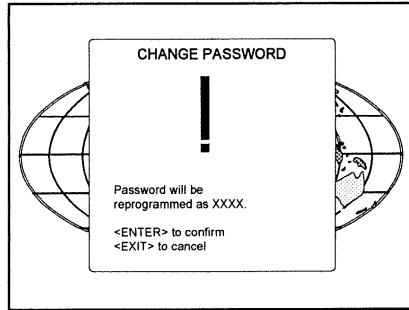

ENTER saves the entered password.
EXIT returns without saving.

Run time

Highlight '*run time*' by pushing the control stick forward or backward and press **ENTER** to display the amount of time the projector has played since its first start up at the factory.

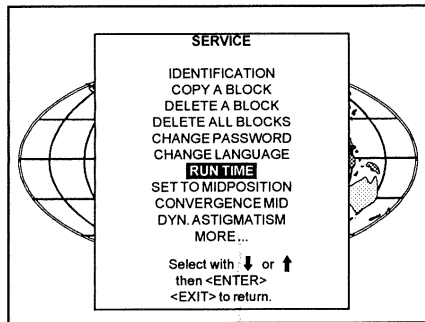

ENTER gives the selected item.
EXIT returns to the path selection main menu.
ADJUST returns to operational mode.

Note : all projectors leave the factory after a burn-in period of approximately 100 hours.

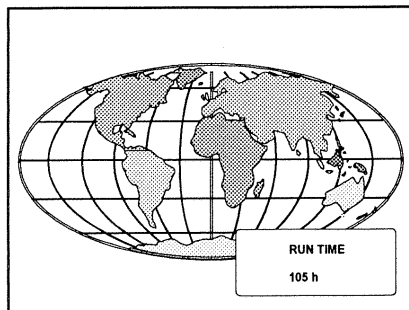

SERVICE MODE

Set to Midposition

Item is password protected.
Highlight '*set to midposition*' by pushing the control stick forward or backward and press **ENTER** to set all settings to their midposition.
A confirmation menu will be displayed first.

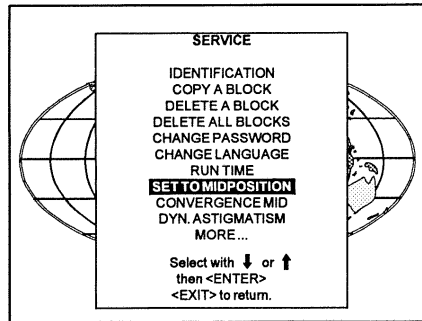

ENTER displays a confirmation screen.
EXIT returns to the path selection main menu
ADJUST returns to operational mode.

ENTER will set all settings to their midposition. **EXIT** will cancel the operation to set all settings to their midposition.

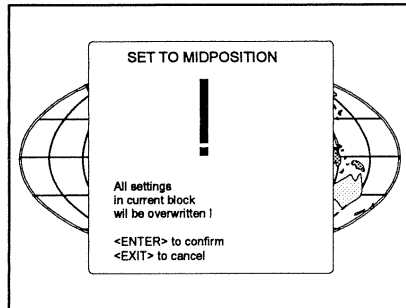

ENTER sets all settings to their midposition
EXIT returns to service mode without changing the settings.

Convergence mid

Item is password protected.
Highlight '*convergence mid*' by pushing the control stick forward or backward and press **ENTER** to set all convergence settings to their midposition. A confirmation screen will be displayed first.

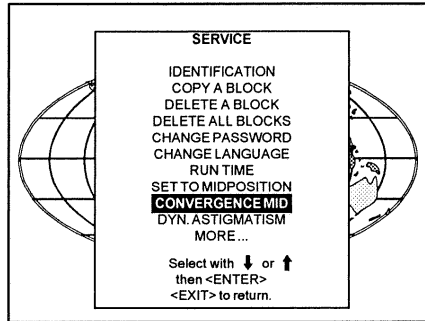

ENTER displays a confirmation screen.
EXIT returns to the path selection main menu
ADJUST returns to operational mode.

ENTER sets the convergence settings to their midposition. **EXIT** cancels the procedure to set the convergence settings to their midposition.

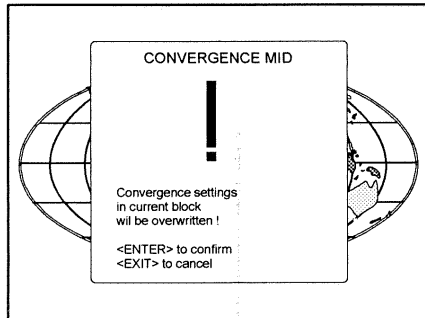

CRT Run In Cycle

The CRT Run In Cycle option can only be activated when memory blocks on an internal # pattern are available. When one or more such blocks are available, a flashing white image (5sec on, 5 sec off) is generated and that for 5 min on the first internal block. In the next 5 min, a second internal block will be used to generate the flashing white image. The image will also be shifted in a vertical way to prevent a CRT burn in. To quit the CRT run in cycle option, press EXIT.

Highlight 'CRT Run In Cycle' by pushing the control stick forward or backward and press ENTER to start .

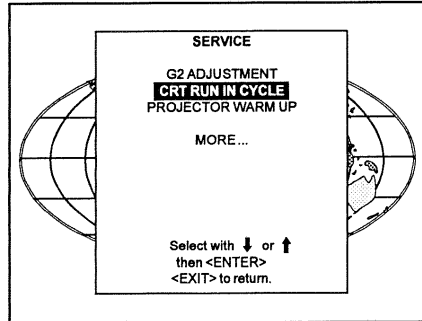

ENTER selects the CRT run in cycle option.
EXIT returns to the path selection main menu

If a memory block adjusted on an internal # pattern is available, the CRT Run In Cycle will start when pressing ENTER. If no such a block is available, the projector cannot enter the CRT Run In Cycle and leaves the adjustment mode.

If you still want to run CRT Run In Cycle, create first a memory block on an internal # pattern and restart the CRT Run In Cycle.

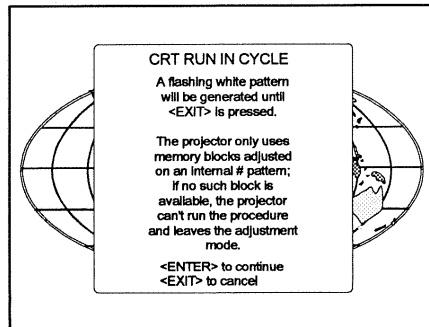

ENTER starts the 'CRT Run In Cycle' when an internal generated # pattern is available.
EXIT returns to the path selection main menu

Copy a block

The copy a block function copies the settings of a selected block into the active block.
 Highlight *copy a block* by pushing the control stick forward or backward and press **ENTER**.

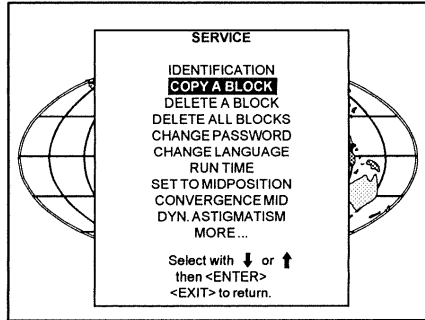

ENTER will select the highlighted item.
EXIT returns to the path selection main menu.
ADJUST returns to operational mode.

To copy the settings of a closed block to the block you are working on (active block), use the arrow keys to select a block.
 All existing settings will be overwritten with the new settings.

Press **ENTER** to copy the selected block. A confirmation screen will be displayed.

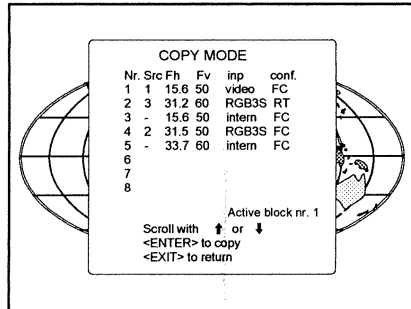

ENTER displays a confirm screen.
EXIT returns to the service mode main menu.

SERVICE MODE

If you are certain you wish to copy the contents of the selected block into the active block, press **ENTER**. **EXIT** cancels the copy procedure and returns without copying the block.

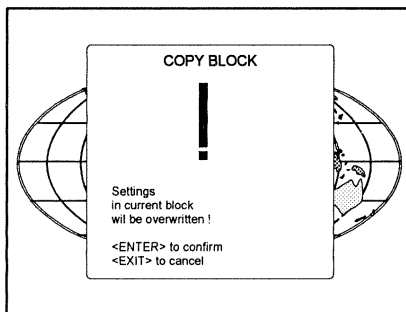

Deletion of blocks

This item is password protected.

The delete function is used to clear all data (settings) from an adjustment block

A delete can be given :

- block by block
- or
- for all blocks.

Deleting block by block

The delete a block function deletes the settings of a selected block.

Highlight '*Delete a block*' by pushing the control stick forward or backward and press **ENTER**.

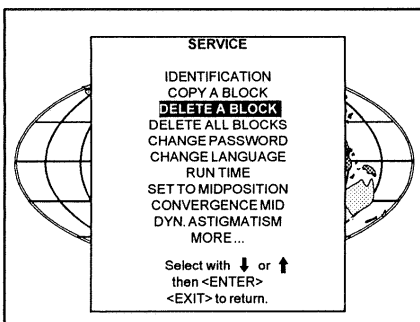

ENTER will select the pointed item.
EXIT returns to the path selection main menu
ADJUST returns to operational mode..

Push the control stick forward or backward to select the desired adjustment block. Press **ENTER** to delete the selected adjustment block. A confirmation menu will be displayed.

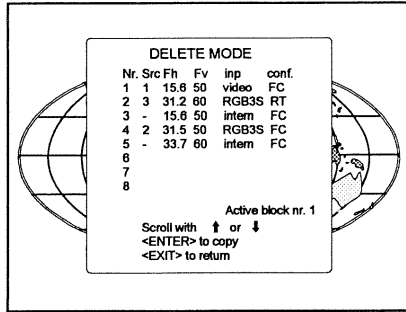

ENTER displays the confirmation menu.
EXIT returns to the service mode main menu.

ENTER will delete the selected block
EXIT cancels the deletion procedure and returns to the service mode main menu.

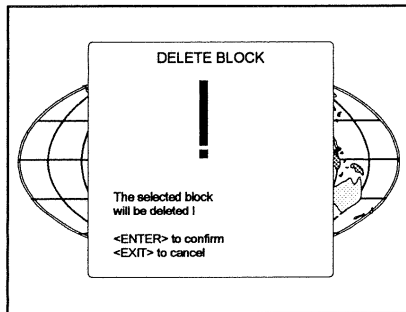

Deletion of all blocks

Highlight *'delete all blocks'* by pushing the control stick forward or backward and press **ENTER**.

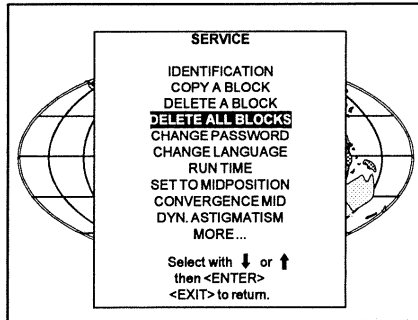

ENTER gives a confirmation message before deleting.
EXIT returns to the path selection main menu

SERVICE MODE

If you are certain you wish to delete all blocks, press **ENTER** to confirm, otherwise press **EXIT** to return.
Once **ENTER** is pressed, all block headers and adjustment settings are permanently removed and cannot be restored.

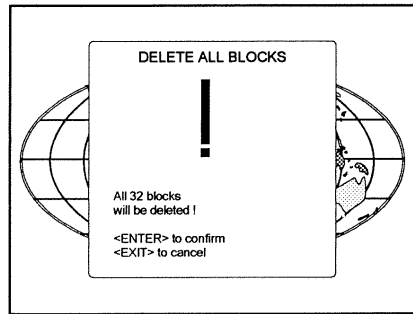

G2 Adjust

Item is password protected.
Highlight 'G2 adjust' with the arrow keys and press **ENTER** to continue.
A safety notice will be displayed on the screen as it is necessary to open the top cover to adjust the G2.

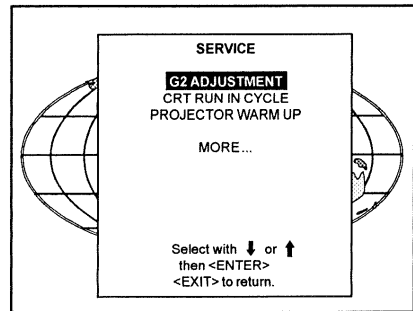

ENTER selects the G2 adjustment.
EXIT returns to the path selection main menu.
ADJUST returns to operational mode.

'G2 adjustment should be performed by BARCO personnel, or BARCO authorized dealers'.

If you are qualified, press **ENTER** to continue. If not qualified, press **EXIT** to return to the service mode main menu. Further description of the G2 adjustment is given in the Installation Manual.

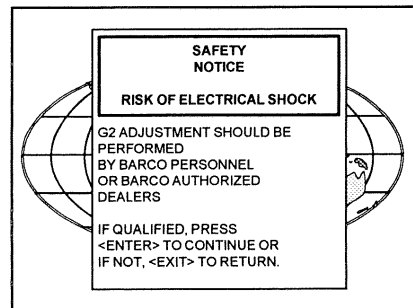

Change language

The 'Change Language' function offers the possibility to change the language of the on screen menus to :

- English
- Spanish
- French
- German

therefore, push the control stick forward or backward to highlight "Change language" and press **ENTER** to select the language menu.

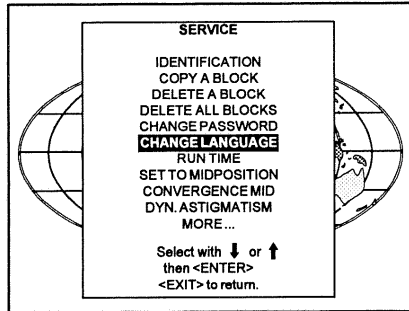

ENTER will select the pointed item.
EXIT returns to the path selection main menu.
ADJUST returns to operational mode.

Push the control stick forward or backward to select the desired language and press **ENTER** to change the language.

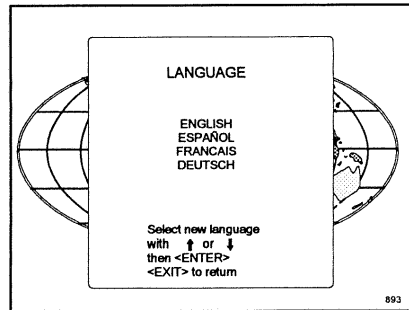

ENTER changes the language.
EXIT returns to the service mode menu.

Projector Warm Up

Highlight 'Projector Warm Up' by pushing the control stick forward or backward and press **ENTER** to select the projector warm up menu.

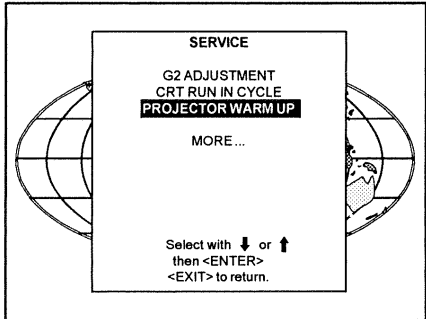

ENTER selects the projector warm up menu.
EXIT returns to the path selection menu.

The ON/OFF option can be toggled with the **ENTER** key.

When in the ON position (and the CRT run in cycle is OFF), the projector can start up with a warm up period of 20 minutes. During the start up a warm up menu will be displayed. This menu offers the possibility to skip the warm up period anyway by pressing the **EXIT** key and offers the possibility to adjust the horizontal and

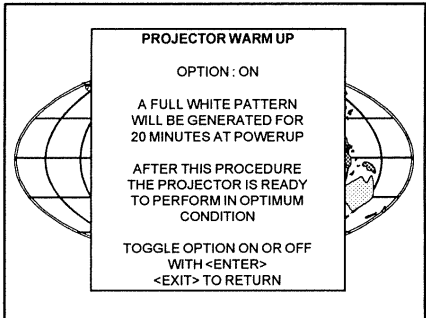

vertical amplitude of the this white image with the control stick. During this warm up period, a full white image is shifted on the CRT faceplate to avoid a burn in. Every 30 seconds a text box will be displayed on another place on the screen with the remaining time to go.

When **EXIT** is pressed during this warm up period, the warm up menu will be redisplayed with the remaining time indication. Press another time **EXIT** to interrupt the warm up cycle.

When the warm up option is OFF, when switching on the the projector, it starts immediately with the projection of the selected source.

Dynamic Astigmatism (spot shape adjustment)

The spot shape adjustments correct the spot shape in 8 different areas on the screen and that for the three colors separately.

The spot shape is adjusted according to the axial axes and the diagonal axes when using the arrow keys on the RCU.

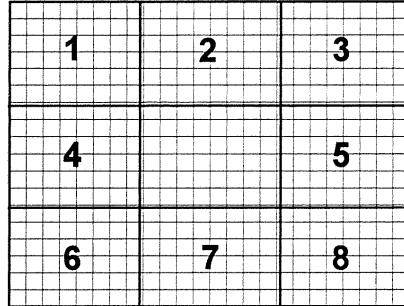

Spot shapes before dynamic astigmatism correction

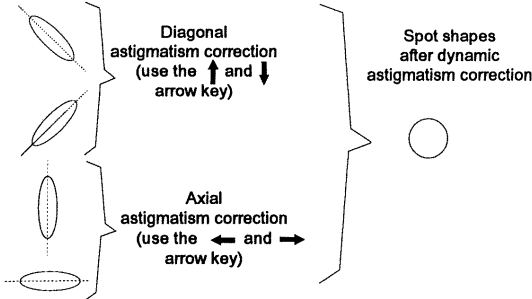

These adjustments have to be done on a dot pattern (e.g. the internally generated pattern) with standard line frequency (15 kHz). The adjustment values are stored in the EEPROM and remain the same for all frequencies.

Follow the next procedure :

Highlight 'Dyn. Astigmatism' by pushing the joy stick forward or backward and press **ENTER** to select.

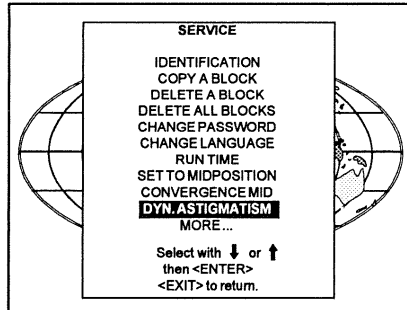

ENTER selects the Dyn. Astigmatism color selection menu.
EXIT returns to the path selection main menu.

SERVICE MODE

Select the source type, selected source or genlock pattern, by highlighting the color for which the spot shape has to be corrected and press ENTER.

e.g. when selecting RED under 'on genlocked pattern', the projector switches to a genlocked pattern.

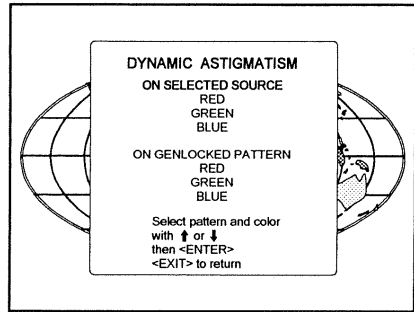

818

ENTER displays the selected color.
EXIT returns to the service main menu.

Press ENTER to continue adjustment. Increase the contrast level using the Contrast Control to near maximum. Using that "+" Sharpness Key, defocus the image until the dots are large and easily visible. Press ENTER to continue to SEL.

SEL : select the adjustment area on the screen where the spot shape has to be corrected.

Use the arrow keys to select one of the 8 areas. Press ENTER to continue to ADJ.

ADJ : adjust the spot shape in the axial or diagonal direction when using the arrow keys for the selected area. Adjust until the spot shape is circular.

Use the up and down arrow keys for the diagonal astigmatism adjustment and the left and right arrow keys for the axial astigmatism adjustment. Press ENTER to continue selecting a new area.

The adjustment direction (axial or diagonal) and adjustment value are given in a text box on the screen. When all areas are adjusted, press EXIT to return to the service main menu.

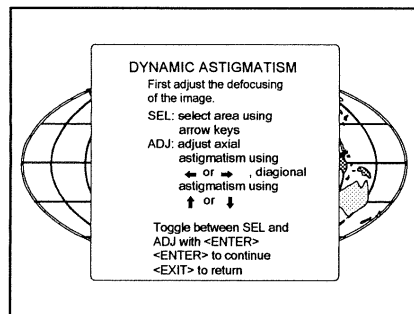

819

OPTIONS

IR receiver 800

Hardwired RCU

Projector Control Software

RCVDS 800 and RCVDS05

VS05

IRIS 800

MAGIK interface

Adapter and Communication Cables

Ceiling Mount Kit

Soft Edge Matching Kit

Contrast Modulation Kit

Orbiting Kit

IR Receiver 800

This infrared receiver unit makes it possible to control the BARCODATA 808 from another room.

There is a communication line with cable between the IR receiver and the projector or the RCVDS800 or RCVDS05. The control information from the RCU can now be sent to this IR receiver.

The IR receiver 800 displays the selected source on a 7-segment display.

Order number : R9827515

Hardwired RCU.

The control signals from the RCU can be sent to the projector via a wired connection.

Preparing your remote cable :

Use a shielded cable with a maximum length of 100 m and two mini-jack 3.5 mm connectors (order number : R3131991).

- Peel back the vinyl covering of the cable on both sides and twist the wire core.

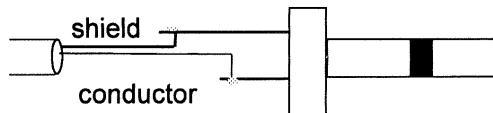

- Solder a jack plug as shown in drawing above to each end of the cable.

shield = ground

conductor = data information

When the cable is ready, plug one side in the remote control and the other side in the connector on the rear of the projector labelled 'remote'.

OPTIONS

Projector Control software

The software is user-friendly and makes full use of : mouse control, pull down menus and dialog boxes.

Two main applications are available with this software : remote control and transferring and receiving data of projector settings.

Remote Control Simulation. Advantage : address range 0 to 255.

Adjustment Data : where can it be located when a IBM PC (or compatible) or MAC or Workstation is connected :

- hard memory device with files of settings.
- the contents of the local memory of the computer.
- the contents of the projector.

RCVDS 800 and RCVDS 05 Switchers

An optional RCVDS 800 source selector makes it possible to connect up to ten sources to the projector, an optional RCVDS05 makes it possible to connect up to 20 sources to the projector. When RCVDS's are linked via the expansion module, even 90 inputs can be connected to the projector.

The selected source number will be displayed on a 2 digit display and the selected input module will be indicated with a LED on the rear.

Order Numbers RCVDS 800:	110V: 9827458	220V: 9827450
	9827459	9827451
Order Numbers RCVDS 05:	110V: 9827888	220V: 9827880
	9827889	9827881

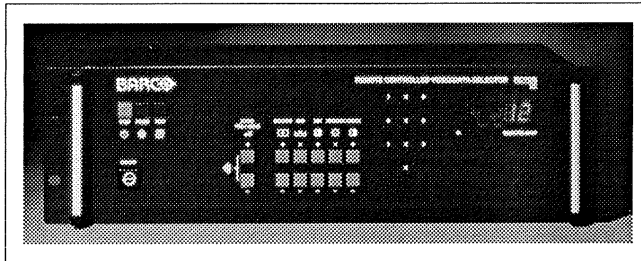
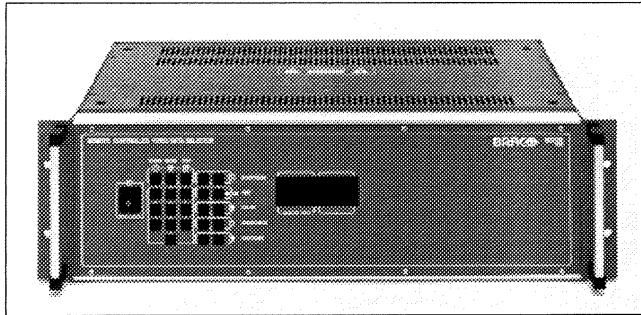

VS05 Switcher

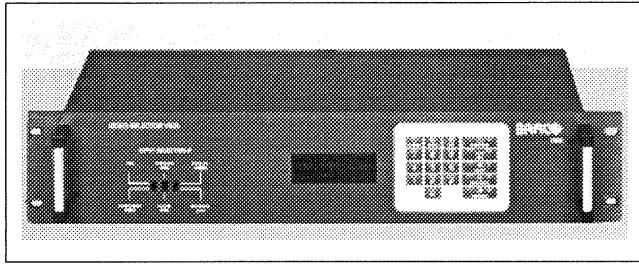

The VS05 is a versatile Video and HDTV source selector for all BARCO's digitally controlled large screen projectors. It offers the possibility to connect and switch up to 5 different Video sources, 3 different S-Video sources and 1 RGB Analog source to a BARCO projector. In addition, the audio signal proper to the source, can be switched to an audio amplifier.

Order Numbers: 110V: 9827890
 220V: 9827899

IRIS 800 Auto-Convergence Unit

Easy-to-use, high precision automatic convergence system. Using the IRIS 800's user-friendly onscreen displays, the unit effortlessly aligns the projected image on the screen faster and more accurately than ever previously possible through the conventional 'manual' convergence process. The flexible design of the IRIS 800 allows it to operate either in a table or ceiling mount installation.

Order Number: 9827695

MAGIK Interface

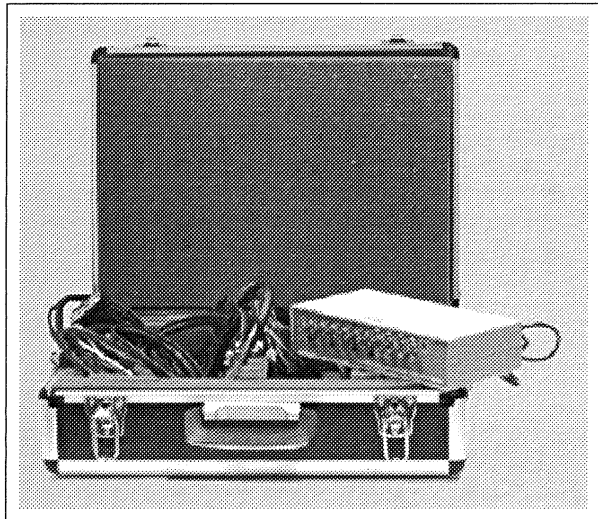

OPTIONS

Multifunctional Analog Graphics Interface Kit.

BARCO's MAGIK interface allows the user to connect a presentation device such as a projector or a professional monitor to any computer with analog video signal with or without maintaining the connection with its own display. The MAGIK interface buffers and amplifies any RGB analog signal with TTL or analog sync without signal loss or image degradation.

The MAGIK can be delivered together with connection cables for PC, MAC, SUN or workstation in a nice handbag case.

Order numbers MAGIK with cables and case :

R9828120 (230V)

R9828129 (120V)

Order number MAGIK only :

R9828121 (230V)

R9828128 (120V)

Adapter and communication cables

BARCO provides several cables to connect peripheral equipment to the BARCO-DATA 808.

a. D9-D9 communication cable

- To connect an IBM PC (or compatible) to the projector.
- To connect a RCVDS 800 or RCVDS05 to the BARCODATA 808.
- To connect a IR receiver to the RCVDS800 or RCVDS05 or to the BARCO-DATA 808.
- To be used as extension cable for all other adapter cables.

Available length : 5 m (16ft), order number R982770; 15 m(50ft), order number R9827640; and 30 m (100ft), order number R9827570

b. Din Mini8-D9 adapter cable.

- To connect a Macintosh computer to the BARCODATA 808.
- Available length : 1 m (3,2 ft), order number R9827640.

c. D25-D9 adapter cable

- To connect a workstation to the BARCODATA 808.
- Available length : 1 m (3,2 ft), order number R9827630

d. 5 BNC to 5 BNC cable

- To connect an analog source to the BNC input of the projector
- Available length: 60 cm, order number R9828260
 150 cm, order number R9828261
 5 m, order number R9828262
 15 m, order number R9828263

Ceiling Mount kit CM100

This heavy duty Ceiling Mount Kit enables the projector to be installed in any ceiling mount application. A heavy duty pulley system facilitates installation and maintenance.

order number : R9827341

Contrast Modulation Kit

The Contrast Modulation Kit is designed to improve overall light output uniformity and to overcome the inherent color shift errors, normally associated with CRT projection. The laws of physics applied to projection optics dictate that the center of the projected image will be brighter than the corners, this phenomenon is normally referred to as 'corner fall off'. Due to the normal off-axis projection of the red and blue images, CRT projection displays a phenomenon referred to as 'color shift', whereby one side of the image is redish and the other bluish. By modulating the amplitude of the video signal with appropriate waveforms we are able to overcome both problems.

The use of this contrast modulation kit is described in appendix C.

Order number : R9827800

Orbiting Kit

Static pictures are very often shown on large screen projectors, especially in process control and presentation applications. Due to the fact that the same picture information is shown for a long period in the same place, picture tubes can be damaged by 'local burn-in'. To reduce this problem, a special Orbiting circuit is available which moves the picture very slowly around a predefined screen area. The cycle time is very long to make the movement of the projected image imperceptible. The use of the orbiting kit is described in appendix A.

Order number : R9827780

Soft Edge Matching Kit

Multi-screens are popular for many applications. In these installations, the goal is to obtain a contiguous matched image, forming one homogenous view. The Soft Edge Matching feature provides a solution to the annoying side effects when adjusting two or more projected images next to each other. To improve this junction, both images must be overlapping within a certain percentage of the total screen width. During the overlapping period, both video signals are modulated by appropriate waveforms so that the resulting light output equals the rest of the image.

Order Number : R9827810.

APPENDIX A : BATTERY REPLACEMENT IN THE RCU

Battery replacement in the RCU.

Remove the battery cover on the backside of the remote control by pushing the indicated handle a little to the bottom of the RCU. Lift up the top side of the cover at the same time (fig. 1).

Remove the battery from the compartment and disconnect the contact plate (fig. 2). Connect a new 9 V battery (E-block type, e.g. type 6F22S or equivalent) to the contact plate. Insert the battery back into the compartment and put the cover back.

Attention : when a new battery is installed, the projector address must be reprogrammed before using the RCU.

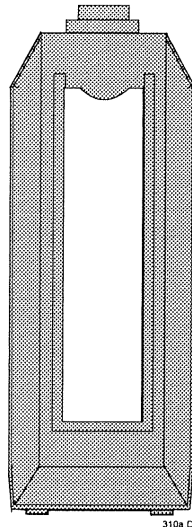
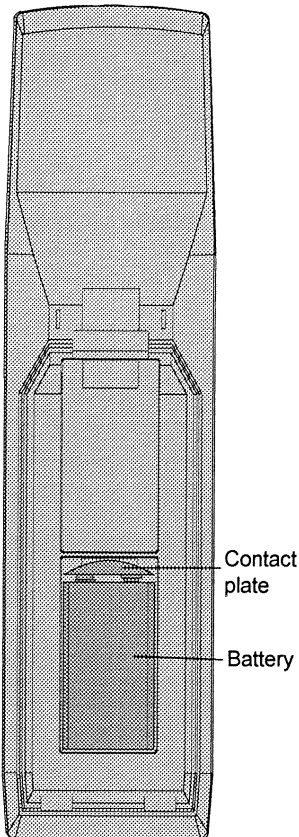

310a DRW

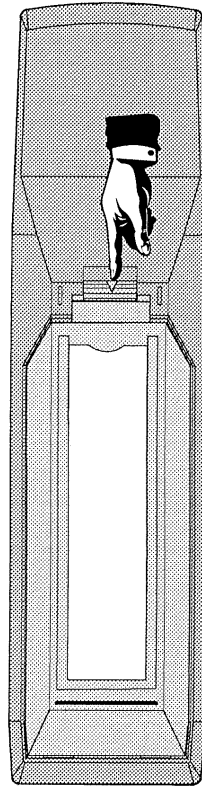

fig.1

fig.2

APPENDIX B : ORBITING

Orbiting (option)

Static pictures are very often shown on large screen projectors, especially in process control and presentation applications. Due to the fact that the same picture information is shown for a long period on the same place, picture tubes can be damaged by 'local burn-in'. To avoid this problem, BARCO has designed special Orbiting circuitry which moves the picture very slow around a predefined screen area. The orbiting circuitry has been designed using a very long cycle time to make the movement of the projected image imperceptible.

Adjustment procedure :

The orbiting path is automatically added to the Random access adjustment mode menu when installed.

Press **ADJUST** to enter the adjustment mode and select Random.

The Random Access Adjustment Mode menu will be displayed.

Highlight **ORBITING** by pushing the joy stick forward or backward and press **ENTER**.

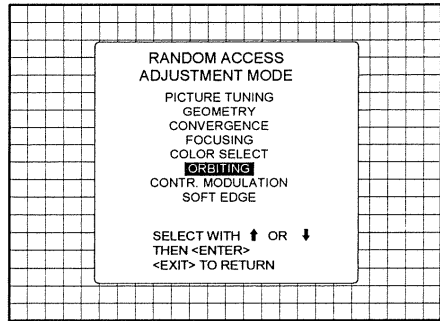

ENTER continues to the Master Orbiting menu.
EXIT returns to operational mode.
ADJUST returns to operational mode.

Orbiting Mode Toggle Switches

The orbiting module is provided with a three pin connector for connection with the BARCO's BCI link option module, used in multiple projector installations. For Orbiting, one projector operates as master whereas the others operate as slave.

Master/Slave Toggle

Highlight '*CHANGE TO SLAVE*' with the joystick and press **ENTER** to set the projector as Slave.

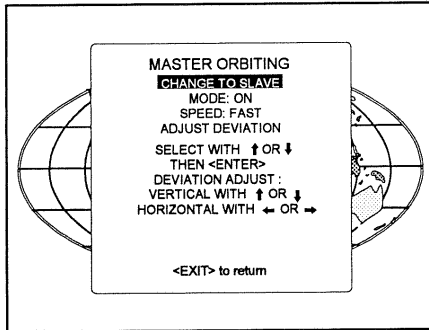

Highlight '*CHANGE TO MASTER*' with the joystick and press **ENTER** to set the projector as Master.

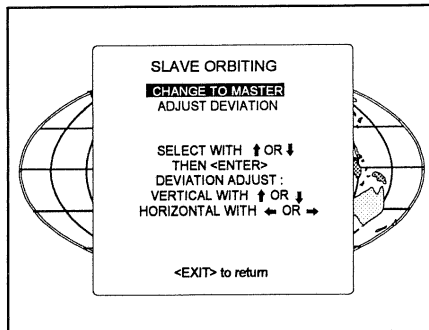

Orbiting ON/OFF toggle (only in Master Orbiting)

Highlight '*MODE : ON*' with the joystick and press **ENTER** to set the ORBITING OFF.

Highlight '*MODE : OFF*' with the joystick and press **ENTER** to set the ORBITING ON.

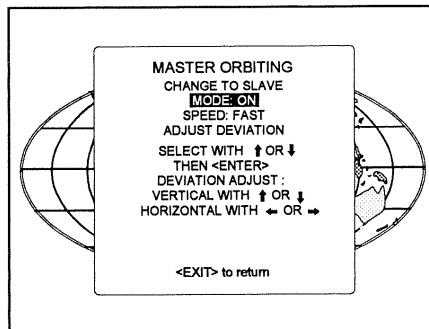

ENTER toggles between mode on and off.
EXIT returns to the Path selection menu.

APPENDIX B : ORBITING

Orbiting Speed Toggle (only in MASTER Orbiting)

Highlight '*SPEED : SLOW*' with the joy stick and press **ENTER** to set the ORBITING SPEED to Fast. Highlight '*SPEED : FAST*' with the joy stick and press **ENTER** to set the ORBITING SPEED to Slow

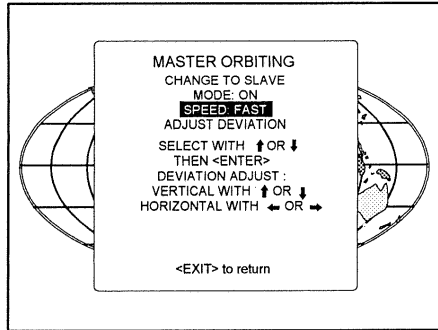

ENTER continues to Set up Orbiting
EXIT returns to path selection menu
ADJUST returns to operational mode

Orbiting Alignment

Preparation :

Before proceeding to the alignment of the Orbiting default settings, be sure that the Horizontal Phase and the Raster shift are correctly aligned with the Orbiting mode set to OFF.

This alignment must be performed in case of a multiple projector installation with Master and Slave projectors in order to ensure a correct operation of the Orbiting for all projectors.

Adjustment procedure Stand-Alone projector :

Highlight '*ADJUST DEVIATION*' with the joy stick and press **ENTER**.

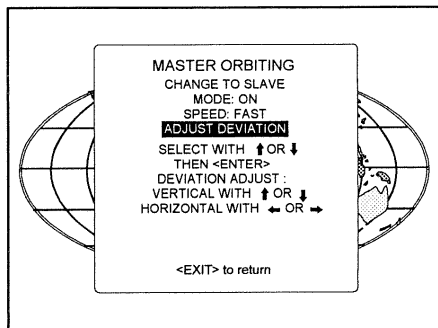

When adjusting the horizontal and the vertical deviation, the picture moves in the corresponding direction, allowing the set up of the deviation without orbiting operation.

Push the joy stick to the right or backward to toggle between Hor. and Vert. deviation andjstment.

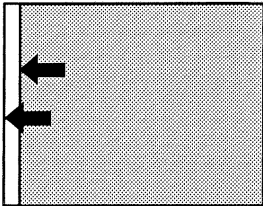

Adjust horizontal deviation by pushing the joy stick to the left or to the right

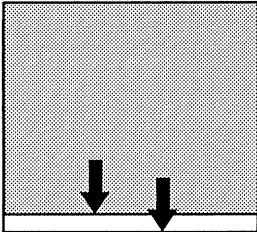

Adjust vertical deviation by pushing the joy stick forward or backward

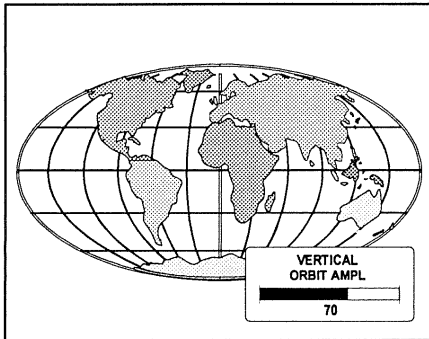
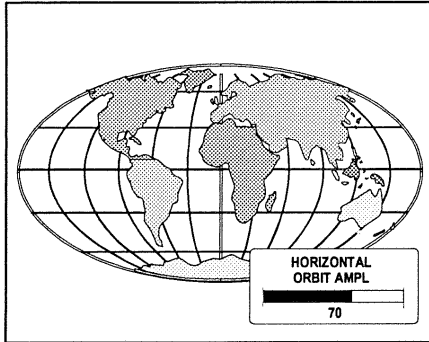

ENTER will select the Orbiting adjustment menu.

EXIT returns to the Path selection menu.

APPENDIX B : ORBITING

Adjustment procedure multiple projector installations :

Important : to allow corrections in the deviation alignments of the slave projectors, never adjust the deviations of the master projector to its maximum.

Default setting of the Master projector see 'Stand-Alone projector'.

Highlight '*ADJUST DEVIATION*' by pushing the joy stick forward or backward and press **ENTER**.

When adjusting the horizontal and the vertical deviation, the picture moves in corresponding direction, allowing the set up of the deviation without orbiting operation.

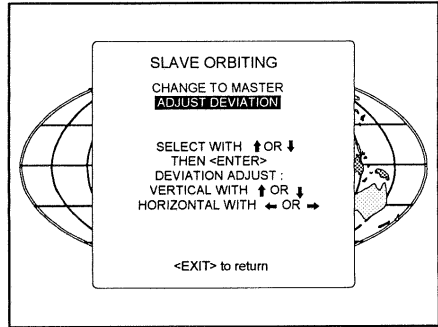

Push the joy stick to the right or backward to toggle between Hor. and Vert. deviation adjustment.

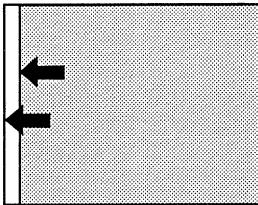

Adjust horizontal deviation by pushing the joy stick to the left or to the right

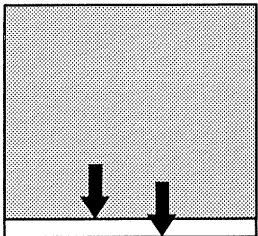
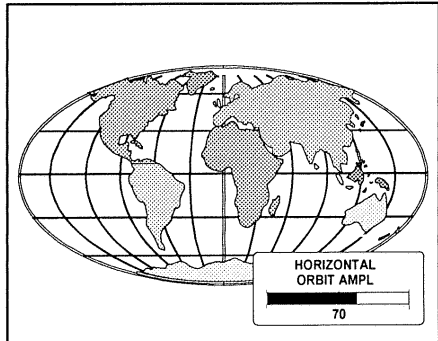

Adjust vertical deviation by pushing the joy stick forward or backward

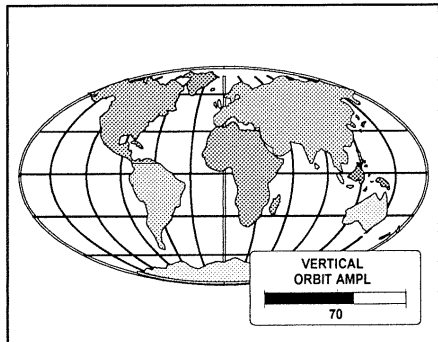

ENTER will select the orbiting adjustment menu.
EXIT returns to the Path selection menu.

APPENDIX C : SOFT EDGE MATCHING

Soft edge matching

Multi-screens are popular for many applications. In these installations, the goal is to obtain a contiguous matched image, forming one homogenous view. The soft edge matching feature provides a solution to the annoying side effects when adjusting two or more projected images next to each other. To improve this junction, both images must be overlapping within a certain percentage of the total screen width. During the overlapping period, both video signals are modulated by appropriate waveforms so that the resulting light output equals the rest of the image.

Picture with hard edging

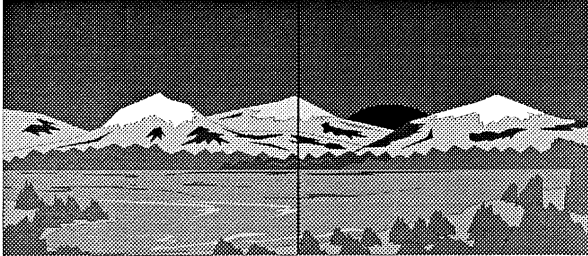

Picture with overlapping

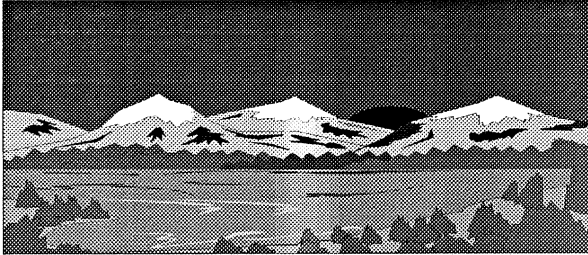

Picture with soft edging

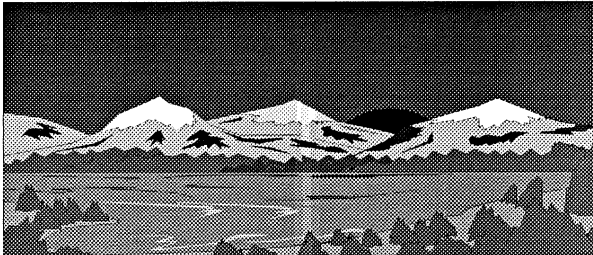

Basic concept

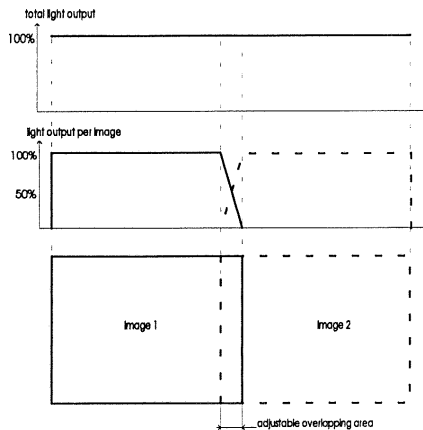

Adjustment procedure :

Start up the adjustment mode by pressing **ADJUST** (see also chapter 'Start up of the adjustment mode')

Highlight *Random access* with the joy stick and press **ENTER** to start up the random access adjustment mode (see also chapter Random access adjustment mode). The *random access adjustment mode main menu* will be displayed.

When the *Soft edge matching option* is installed, the projector automatically detects this option and displays the selection (activation) line in the random access adjustment mode main menu.

Highlight **SOFT EDGE** by pushing the joy stick forward or backward and press **ENTER** to select.

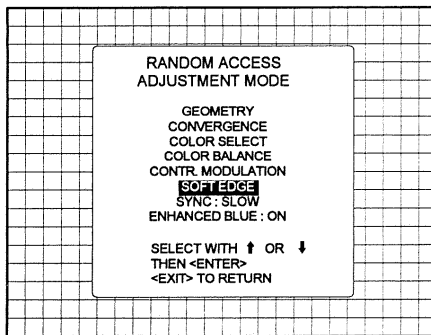

The soft edge correction menu offers the possibility to display a horizontal test pattern and a vertical test pattern. When the test patterns are ON, the 'real' soft edge is disabled, marking lines for the start and stop position of soft edging and the overlapping area are displayed. When the test patterns are OFF, the 'real' soft edge is enabled again.

Note : blanking corrections must be set to display a normal video image.

ENTER displays the soft edge matching menu.
EXIT returns to the Path selection menu.
ADJUST returns to operational mode.

APPENDIX C : SOFT EDGE MATCHING

Each overlap area (left and right) is determined by a start (stop) position and an area width.

The start (stop) position for the top (bottom) overlap area is determined by the blanking adjustment.

Highlight '*H TEST MODE*' and press **ENTER**.

The test image is enabled to adjust the start (stop) position and the area width.

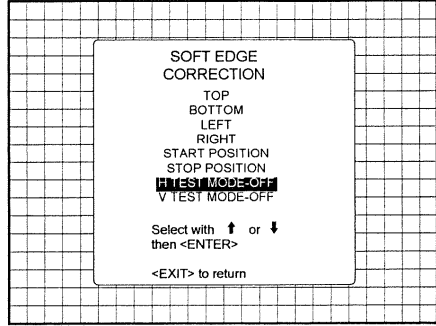

339g

ENTER toggles between H test mode OFF and ON.

EXIT returns to the random access adjustment mode main menu.

ADJUST returns to operational mode.

The test image is projected on the normal image

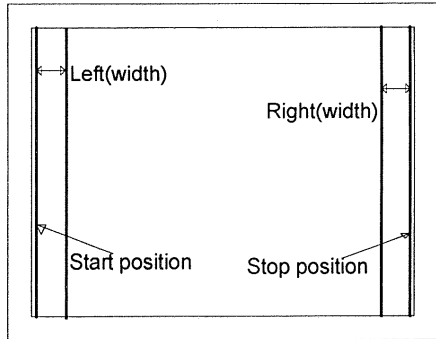

415

Raster Image
 ————— Visible lines

Start position

Highlight *START POSITION* by pushing the joy stick forward or backward and press **ENTER**.

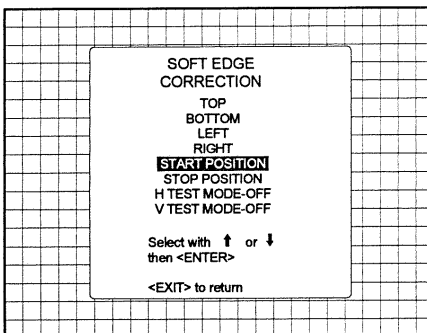

339e

ENTER displays the normal image superimposed with the internal generated test signal.

EXIT returns to the random access adjustment mode main menu.

ADJUST returns to operational mode.

Adjust the first left line of the generated test image to determine the image border. This image border is the start position of the soft edge area.

Note : when the start position is not visible by the first image display, adjust with the joy stick until the line becomes visible. Adjust then until the start position is correct.

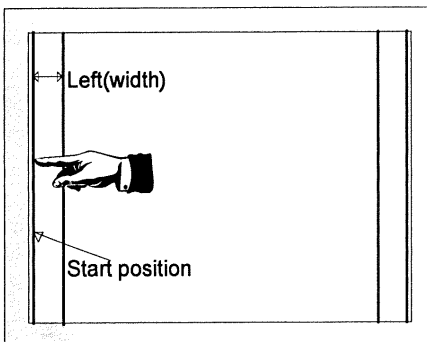

415a

ENTER displays the soft edge menu.

APPENDIX C : SOFT EDGE MATCHING

Left image area

Highlight *LEFT* by pushing the joy stick forward or backward and press **ENTER**.

The normal image superimposed with the test pattern will be displayed.

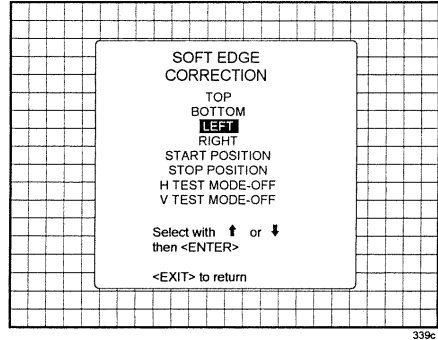

ENTER displays the normal image superimposed with the internal generated test signal.

EXIT returns to the random access adjustment mode main menu.

ADJUST returns to operational mode.

Adjust the left soft edge area width by moving with the joy stick the second test pattern line towards its desired position.

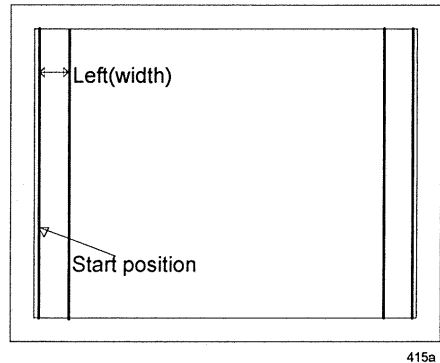

ENTER returns to the soft edge correction menu.

Stop position

Highlight **STOP POSITION** by pushing the joy stick forward or backward and press **ENTER**.

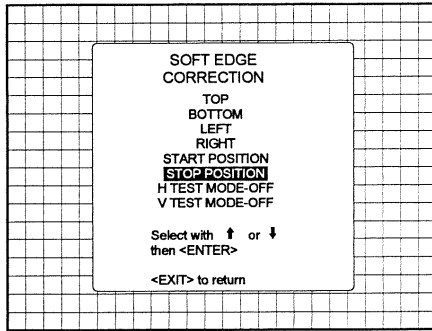

339f

ENTER displays the normal image superimposed with the internal generated test signal.

EXIT returns to the random access adjustment mode main menu.

ADJUST returns to operational mode.

Adjust the last right line of the generated test image to determine the image border. This image border is the end position of the right soft edge area.

Note : when the stop position is not visible by the first image display, push the joy stick until the line becomes visible. Adjust then until the stop position is correct.

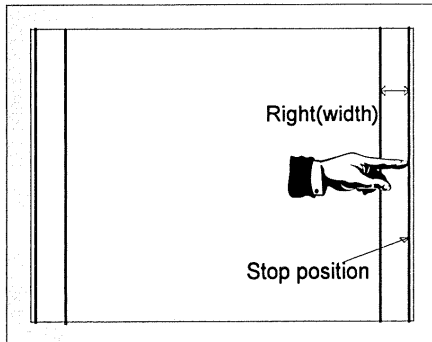

415b

ENTER displays the soft edge menu.

APPENDIX C : SOFT EDGE MATCHING

Right image area

Highlight *LEFT* by pushing the joy stick forward or backward and press **ENTER**.

The normal image, superimposed with the test pattern will be displayed.

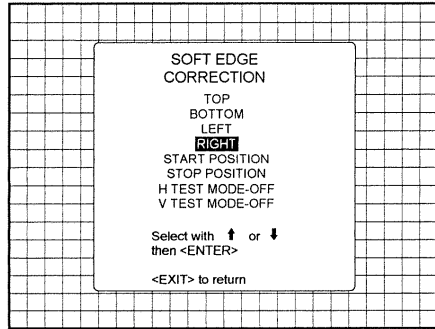

339d

ENTER displays the normal image superimposed with the internal generated test signal.

EXIT returns to the random access adjustment mode main menu.

ADJUST returns to operational mode.

Adjust the right soft edge area width by moving with the joy stick the second test pattern line towards its desired position.

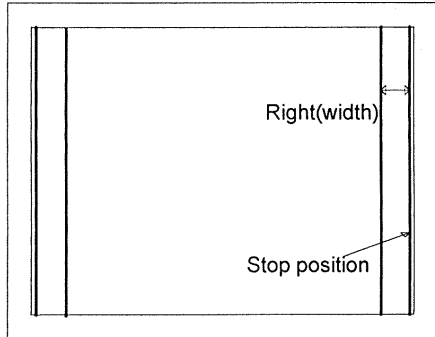

415b

ENTER returns to the soft edge correction menu.

Vertical test mode

Highlight 'V TEST MODE' and press ENTER.

The test image is enabled to adjust the start (stop) position and the area width.

When switching the V test mode to On, the H test mode will switch to OFF.

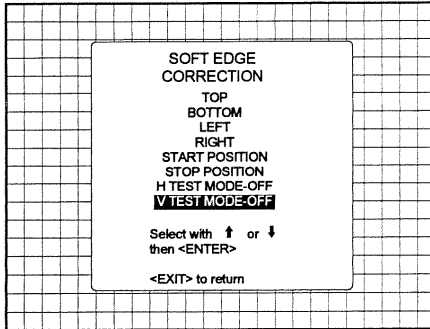

339h

ENTER toggles between V test mode OFF and ON.
 EXIT returns to the random access adjustment mode main menu.
 ADJUST returns to operational mode.

The test image is projected on the normal image. The start (stop) position is determined by the blanking controls. The blanking adjustment is also the image border for the begin (end) position of the soft edge area. Adjust the blanking for a normal video image.

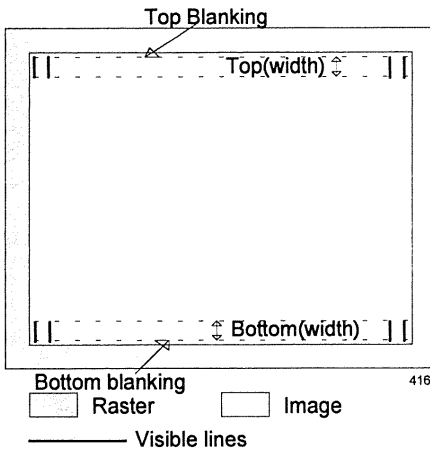

416

APPENDIX C : SOFT EDGE MATCHING

Top soft edge area adjustment

Highlight *TOP* by pushing the joy stick forward or backward and press **ENTER**.

The normal image, superimposed with the test pattern will be displayed.

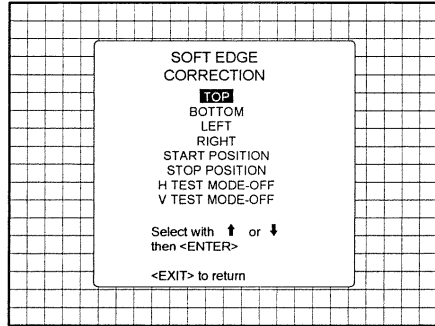

339a

ENTER displays the normal image superimposed with the internal generated test signal.

EXIT returns to the random access adjustment mode main menu.

ADJUST returns to operational mode.

Adjust the top soft edge area width by changing the length of the internal generated lines with the joy stick.

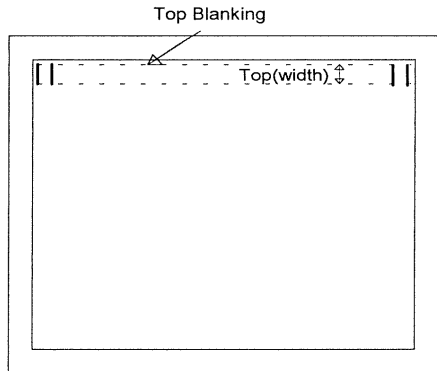

416a

ENTER returns to the soft edge correction menu.

Bottom soft edge area adjustment

Highlight *BOTTOM* by pushing the joy stick forward or backward and press **ENTER**.

The normal image, superimposed with the test pattern will be displayed.

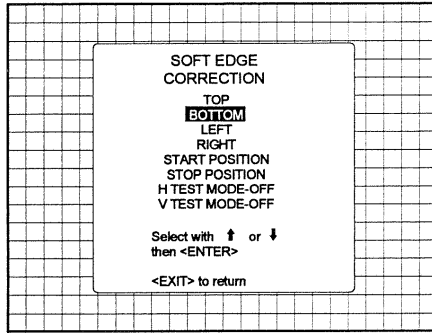

339b

ENTER displays the normal image superimposed with the internal generated test signal.
EXIT returns to the random access adjustment mode main menu.
ADJUST returns to operational mode.

Adjust the bottom soft edge area width by changing the length of the internal generated lines with the joy stick.

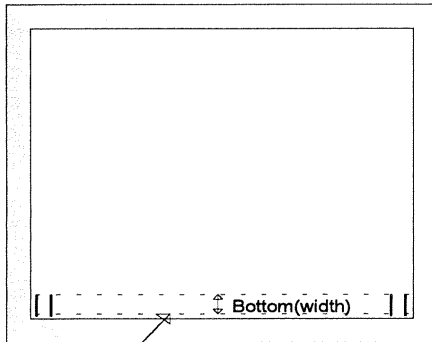

416b

ENTER returns to the soft edge correction menu.

APPENDIX D : CONTRAST MODULATION

Contrast Modulation (option)

Today multi-screens are very popular for many applications e.g. simulation business. In this installations, the goal is to obtain a continuous matched image, forming one homogeneous view. The viewer wants to see an overall light output uniformity.

The laws of physics applied to projection optics dictates that the center of the projected image will be brighter than the corners, this phenomenon is normally referred to as 'corner fall off'. Secondly, due to the normal off-axis projection of the red and blue images, CRT projection displays a phenomenon referred to as 'color shift', whereby one side of the screen is redish an the other bluish.

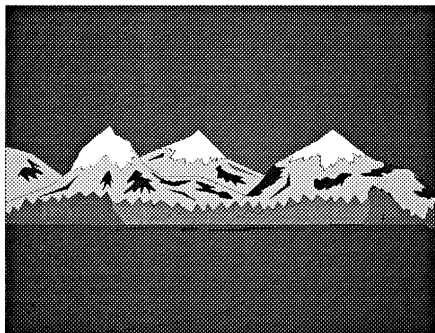

Picture without
contrast modulation

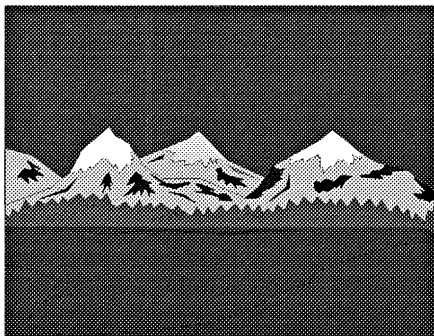

Picture with
contrast modulation

APPENDIX D : CONTRAST MODULATION

Basic Concept

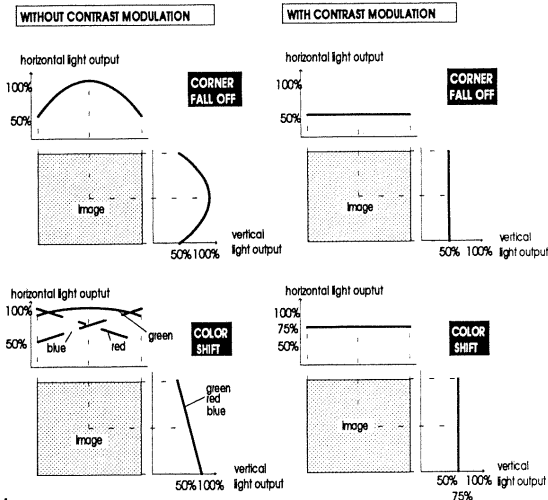

Adjustment procedure :

Start-Up the Adjustment mode by pressing **ADJUST** (see also chapter 'Start-Up of the Adjustment mode')

Highlight *Random access* with the joy stick and press **ENTER** to start up the random access Adjustment mode (see also chapter Random access adjustment mode).

The *random access adjustment mode main menu* will be displayed.

When the *contrast modulation option* is installed, the projector automatically detects this option and displays the selection (activation) line in the random access adjustment mode main menu.

Highlight *CONTR. MODULATION* by pushing the joy stick forward or backward and press **ENTER** to select.

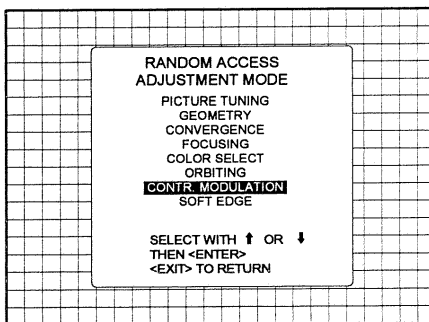

Note : An external generated white image will be useful during the adjustment.

NOTE : be sure the horizontal phase is correctly adjusted. The image must be centered on the raster with the horizontal phase adjustment, otherwise it is not possible to adjust the contrast modulation correctly.

ENTER selects the contrast modulation menu.
EXIT returns to the Path selection menu.
ADJUST returns to operational mode.

APPENDIX D : CONTRAST MODULATION

The first 3 adjustments (horizontal red, green, blue) are used for horizontal light equalisation for the three specific colors separately. This compensates the error due to the different horizontal position of the picture tubes. One side of the image is reddish and the other side is blueish. This phenomenon is called *Color shift*.

The *VERTICAL* adjustment affects the three colors at the same time and corrects the vertical error in light output due to the projection angle (10.5 degrees).

Left-Right (horizontally) and top-bottom (vertically) adjustments improves the '*hot spot*' in the center of the screen.

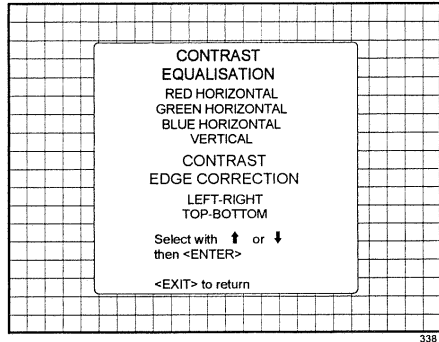

Contrast Equalization ('Color Shift')

Highlight *RED HORIZONTAL* with the joy stick and press **ENTER**. Only a red image is displayed. Use the joy stick to equalize the light output on the left and right side of the image. The best result is obtain on a white image by looking on the left and the right side until both or equal, or by using a very sensitive light meter.

ENTER returns to the Contrast Modulation menu.

Repeat this adjustment for green and blue. by selecting first Green horizontal and than Blue horizontal.

NOTE : When the end of adjustment range is reached for red and blue, the green image will be displayed too, to give you the message 'end of adjustment range'. The green image stays active until a new selection is made.

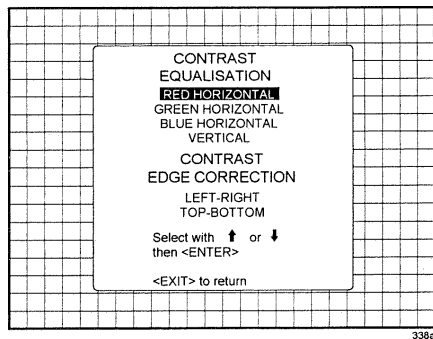

ENTER displays the red image.
EXIT returns to the Random access adjustment mode main menu
ADJUST returns to operational mode.

Highlight **VERTICAL** by pushing the joy stick forward or backward and press **ENTER**. This adjustment is done for on all three colors at the same time.

Use the joy stick to equalise the vertical light output and press **ENTER** to continue.

The best result is obtain on a white image by looking on the top and the bottom side until both or equal, or by using a very sensitive light meter.

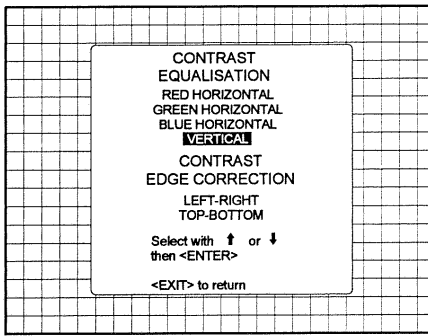

ENTER selects the Vertical contrast equalisation option.
EXIT returns to the Random access adjustment mode main menu.
ADJUST returns to operational mode.

Contrast Edge Correction ('hot spot')

Highlight **LEFT-RIGHT** by pushing the joy stick forward or backward and press **ENTER** to start the horizontal 'hot spot' correction in the center of the screen. Adjust with the arrow keys for the same light output in the corners as in the center of the image.

This left-right adjustment must be done in combination with the top-bottom adjustment as both adjustments influence each other.

NOTE : these adjustments will reduce the total light output, so do not over adjust.

HINT : A bar scale of 10 - 15 for both adjustments gives a good result.

Press **ENTER** to return to the contrast modulation menu.

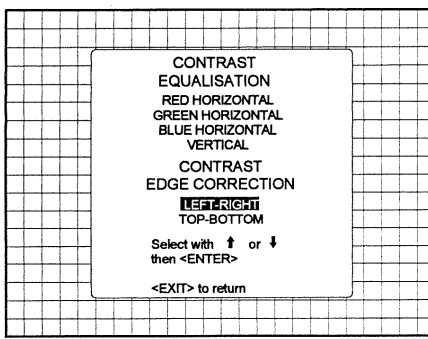

ENTER starts the left-right contrast edge correction.
EXIT returns to the Random Access adjustment main menu.
ADJUST returns to operational mode.

APPENDIX D : CONTRAST MODULATION

Highlight *TOP-BOTTOM* by pushing the joy stick forward or backward and press **ENTER** to start the vertical '*hot spot*' correction in the center of the screen. Adjust with the joy stick for the same light output in the corners as in the center of the image.

This top-bottom adjustment must be done in combination with the left-right adjustments as both adjustments influence each other.

NOTE : these adjustments will reduce the total light output, so do not over adjust.

HINT : A bar scale of 10 - 15 for both adjustments gives a good result.

Press **ENTER** to return to the contrast modulation menu.

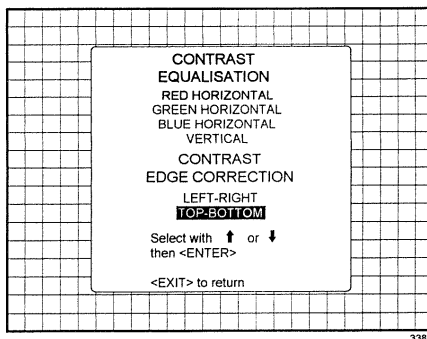

ENTER starts the top-bottom contrast edge correction.

EXIT returns to the Random Access adjustment main menu.

ADJUST returns to operational mode.

Adjustment Blocks (memory blocks)

As the BARCODATA 808 is digitally controlled, all geometry and convergence adjustments are stored in the projector's memory as numeric values. These numeric values are used to control digital potentiometers which in turn, control the projector. Each source connected to the projector has a unique set of adjustment data which is automatically downloaded into the projector's digital potentiometers once the source has been selected. This set of adjustment data is referred to as an "adjustment block".

An adjustment table is automatically created for a source when the source is first connected to the projector and the Adjustment mode is entered. If other sources have already been connected to the projector and geometry and convergence adjustments have been performed on these sources, the projector will use Linear Digital Interpolation to create a new block for the new source. This block will provide an initial set of adjustments for the new source that have been calculated by the projector from "previous experience".

The projector's memory has the capacity to store 32 adjustment blocks. The adjustment block consists of two parts, the block header and the data representing the values for all adjustments (eg. Convergence and Geometry) in the projector for the source the block corresponds to. The block header contains the basic characteristics of the source and the projector configuration used to display the source.

<i>Block Header</i>	<i>example of block header</i>
Block Number	01
Source Number	01
Horizontal Frequency	15.6 kHz
Vertical Frequency	50 Hz
Input Type	video
Scan Switch Configuration	Front/Ceiling

The data representing the various adjustments for the source follows the block header.

APPENDIX F : SOURCE NUMBERS 90 - 99

Source numbers 90 - 99

Source numbers 90 - 99 do not correspond to physical inputs to the projector or RCVDS. They are used to assign an additional adjustment block to a source. This additional adjustment block may contain different geometry and convergence settings, sync fast/slow positions and enhanced blue on/off settings. The relationship between source numbers 0 - 9 and 90 - 99 (projector with RCVDS) or 1 - 5 and 91 - 95 (stand-alone projector) is shown in the diagram below.

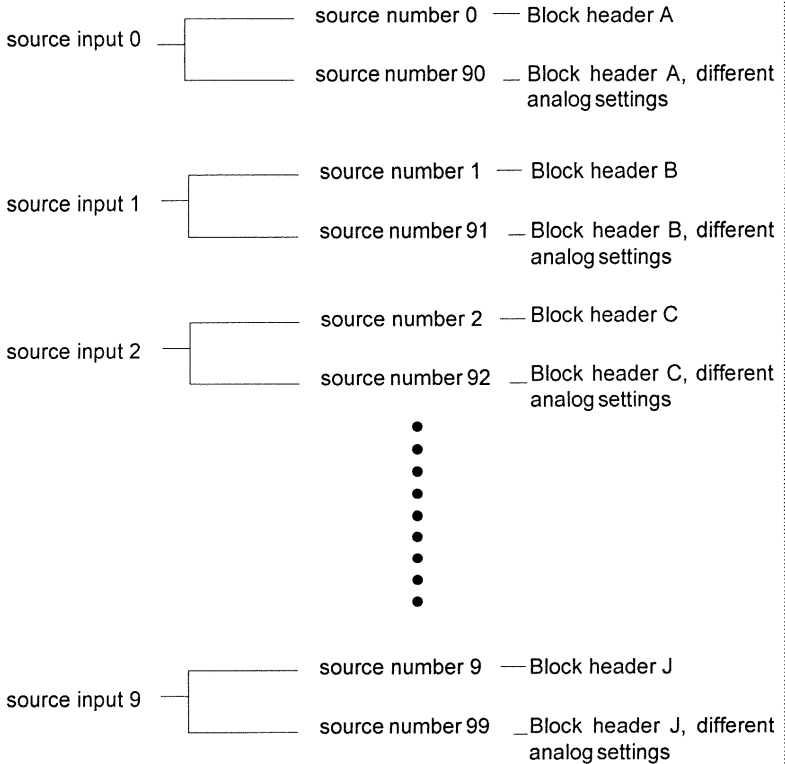

The alternate adjustment block for sources 0 - 9 (projector with RCVDS) or 1 - 5 (stand-alone projector) is activated by selecting the corresponding source number 0 - 9 (projector with RCVDS) or 1 - 5 (stand-alone projector). Once this source number is selected, the alternate block of adjustment data is in use and may be modified via the adjust mode of the projector. The alternate adjustment block is automatically stored.

APPENDIX F : SOURCE NUMBERS 90 - 99

Follow the steps below to create a second adjustment block for a source between 0 and 9.

1. Select the source between 0 and 9 that the second adjustment block is to be created for.
2. Select the corresponding source number between 90 and 99. The adjustment block for the source number between 0 and 9 is copied to the corresponding source number between 90 and 99.
3. Enter the adjust mode and make any desired changes (geometry, convergence, sync fast/slow, enhanced blue on/off) to the second adjustment block.
4. Exit the adjust mode.

Note : the above also applies to source number 1 - 5 and 91 - 95 of a stand alone projector (no RCVDS)

MATERIAL SAFETY DATA SHEET	Form Approved Bureau Budget No. 45-R0338
-----------------------------------	---

SECTION I	MANUFACTURER'S NAME AND FSCM (Federal Supply Code for Manufacturer's) <i>BARCO N.V.</i>		EMERGENCY PHONE NO. <i>32-56-368211</i>
	ADDRESS (Number, Street, City, State, and ZIP Code) <i>Noordlaan 5 B-8520 KUU'RNE</i>		
	CHEMICAL NAME AND SYNONYMS <i>Ethylenglycol & Glycerol</i>		TRADE NAME AND SYNONYMS <i>Cooling liquid 512334</i>
	CHEMICAL FAMILY <i>Polyalcohols</i>	FORMULA <i>C₂H₆O₂+C₃H₈O₃</i>	
	FEDERAL STOCK NUMBER (FSN)	GROSS WEIGHT (LBS)	OUTSIDE PACKAGE DIMENSIONS (Inches)
	MIL-STD-1341/NATIONAL FIRE PROTECTION ASSOCIATION STD 704M SIGNAL		

SECTION II - HAZARDOUS INGREDIENTS	PAINTS, PRESERVATIVES, AND SOLVENTS	%	TRESHOLD LIMIT VALUE (Units)	ALLOYS AND METALLIC COATINGS	%	TRESHOLD LIMIT VALUE (Units)	
	PIGMENTS	/		BASE METAL	/		
	CATALYST	/		ALLOYS	/		
	VEHICLE	/		METALLIC COATINGS	/		
	SOLVENTS	/		FILLER METAL PLUS COATING OR CORE FLUX	/		
	ADDITIVES	/		OTHERS	/		
	OTHERS	/					
	HAZARDOUS MIXTURES OF OTHER LIQUIDS, SOLIDS, OR GASES					%	TRESHOLD LIMIT VALUE (Units)

SECTION III PHYSICAL DATA	BOILING POINTS (°C.)	<i>201°C</i>	SPECIFIC GRAVITY (H ₂ O=1)	<i>1.15</i>
	VAPOR PRESSURE (mm Hg.)	<i>3 mm Hg</i>	PERCENT VOLATILE BY VOLUME (%)	/
	VAPOR DENSITY (A/R=1)	<i>2.2</i>	EVAPORATION RATE (.....=1)	/
	SOLUBILITY IN WATER	<i>∞</i>		
	APPEARANCE AND ODOR			

SECTION IV - FIRE AND EXPLOSION HAZARD DATA	FLASH POINT (Method used)	FLAMMABLE LIMITS	LOWER EXPLOSIVE LIMIT	UPPER EXPLOSIVE LIMIT
	EXTINGUISHING MEDIA			
	SPECIAL FIRE FIGHTING PROCEDURES			
	UNUSUAL FIRE AND EXPLOSION HAZARDS			

SECTION V HEALTH HAZARD DATA	TRESHOLD LIMIT VALUE <i>100ppm</i>		
	EFFECTS OF OVEREXPOSURE		
	EMERGENCY AND FIRST AID PROCEDURES		
SECTION VI REACTIVITY DATA	STABILITY	UNSTABLE	CONDITIONS TO AVOID
		STABLE	X
	INCOMPATABILITY (<i>Materials to avoid</i>)		
	HAZARDOUS DECOMPOSITION PRODUCTS		
	HAZARDOUS POLYMERIZATION	MAY OCCUR	X
	WILL NOT OCCUR		
SECTION VII SPILL OR LEAK PROCEDURES	STEPS TO BE TAKEN IN CASE MATERIAL IS RELEASED OR SPILLED		
	<i>Rinse with water</i>		
	WASTE DISPOSAL METHOD		
SECTION VIII - SPECIAL PROTECTION INFORMATION	RESPIRATORY PROTECTION (<i>Specific type</i>)		
	VENTILATION	LOCAL EXHAUST	SPECIAL
		MECHANICAL (<i>General</i>)	OTHER
	PROTECTIVE GLOVES		EYE PROTECTION
	OTHER PROTECTIVE EQUIPMENT		
SECTION IX SPECIAL PRECAUTIONS	PRECAUTIONS TO BE TAKEN IN HANDLING AND STORING		
	<i>Harmful if swallowed</i>		
	<i>Keep out of the reach of children</i>		
	OTHER PRECAUTIONS		
<i>To avoid from oxidants</i>			

THE INFORMATION CONTAINED HEREIN IS BASED ON DATA CONSIDERED ACCURATE. HOWEVER, NO WARRANTY IS EXPRESSED OR IMPLIED REGARDING THE ACCURACY OF THESE DATA OR THE RESULTS TO BE OBTAINED FROM THE USE THEREOF. VENDOR ASSUMES NO RESPONSIBILITY FOR INJURY TO VENDEE OR THIRD PERSONS PROXIMATELY CAUSED BY THE MATERIAL IF REASONABLE SAFETY PROCEDURES ARE NOT ADHERED TO AS STIPULATED IN THE DATA SHEET. ADDITIONALLY, VENDOR ASSUMES NO RESPONSIBILITY FOR INJURY TO VENDEE OR THIRD PERSONS PROXIMATELY CAUSED BY ABNORMAL USE OF THE MATERIAL EVEN REASONABLE SAFETY PROCEDURES ARE FOLLOWED. FUTUREMORE, VENDEE ASSUMES THE RISK IN HIS USE OF THE MATERIAL.

BARCO nv/Projection Systems

Noordlaan 5
B-8520 Kurne
Belgium

Printed in Belgium

Insert card for RCU

* Only available when the optional Tri-level sync module is installed.

RCU	
INPUT SOURCES	
PROJECTOR	
1	Video
2	S-Video
3	RGB Analog
4	RGsB
5	RGB-S
6	RGsB*
7	RGB-3S*
INPUT SOURCES	
RCVDS	
1	
2	
3	
5	
6	
7	
8	
9	
10	

59 75045

RCU	
INPUT SOURCES	
RCVDS	
1	
2	
3	
5	
6	
7	
8	
9	
10	
11	
12	
13	
14	
15	
16	
17	
18	
19	
20	

59 75045



PLEASE READ

This manual is provided as a free service by Projector.com.

We are in no way responsible for the contents of the manual. We do not guarantee its accuracy and we do not make any claim of copyright. The copyright remains the property of their respective owners.

ABOUT PROJECTOR.COM

Projector.com (<http://www.projector.com>) is your review and buying guide resource for DLP and LCD video projectors.

Visit the site to read the latest projector news and reviews, read and comment on projector specifications, download user manuals and much more.